

Doppelfenster

Double window / Double fenêtre / Dubbel raam / Dvojité okno

309924

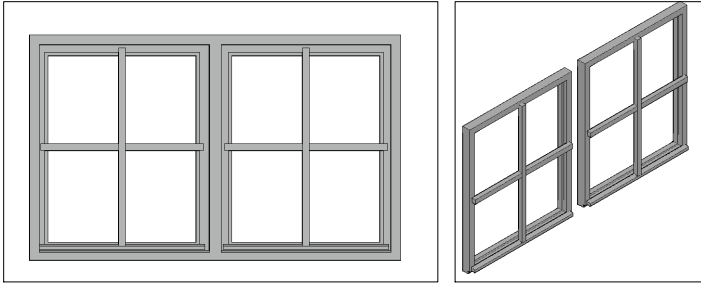

UH126/76-217

2 x UH4/6, l=132,5cm

2 x UH4/6, l=120cm

(nur bei Profilschalung / only for profiled formwork / seulement pour le coffrage profilé / seulement pour le coffrage profilé / Alleen voor profielbekisting / Pouze pro profilované bednění / Len pre profilové debnenie)

2 x A100-220S, l=129,1cm

10 x C104-0030, 30mm

52 x C105-0040, 40mm

18 x C105-0050, 50mm

14 x C105-0100, 100mm

8 x B105-040, 40mm

Außenseite, Outside,
Extérieur, Buiten, Mimo, Mimo

2x

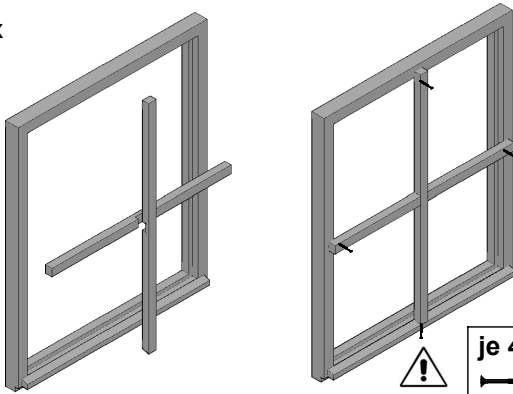

je 4x B105-040
40mm

Einbau bei Deckelschalung

Installation with cover formwork / Montage pour coffrage de couvercle / Montage met dekselbekisting / Montáž s krycím debněním / Instalace s krycím bedněním

1.

Innenseite, Inside, Intérieur,
Binnen, Vnůtri, Uvnitř

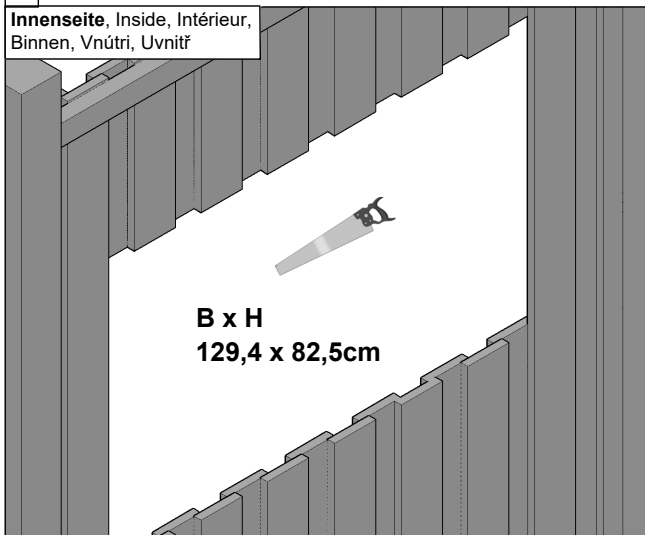

B x H
129,4 x 82,5cm

Einbau bei Profilschalung

Installation with profiled formwork / Montage pour coffrage profilé / Montage met profielbekisting / Montáž s profilovaným debněním / Instalace s profilovaným bedněním

1.

Innenseite, Inside, Intérieur,
Binnen, Vnůtri, Uvnitř

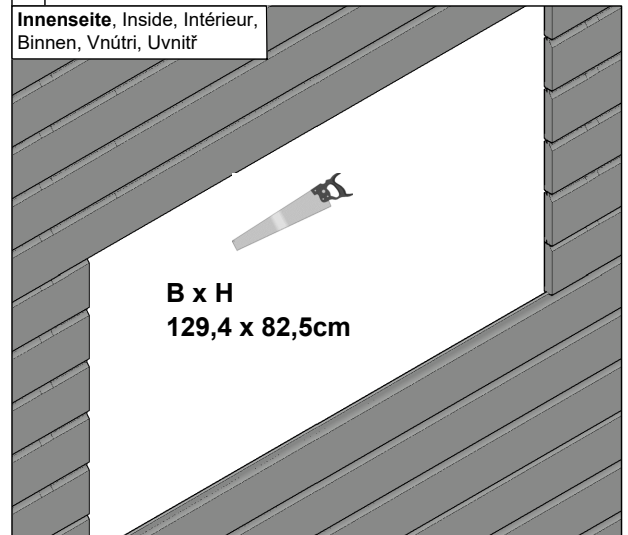

B x H
129,4 x 82,5cm

Doppelfenster

Double window / Double fenêtre / Dubbel raam / Dvojité okno



Einbau bei Deckelschalung

Installation with cover formwork / Montage pour coffrage de couvercle / Montage met dekselbekisting / Montáž s krycím debnením / Instalace s krycím bedněním

2.

Außenseite, Outside, Extérieur, Buiten, Mimo, Mimo

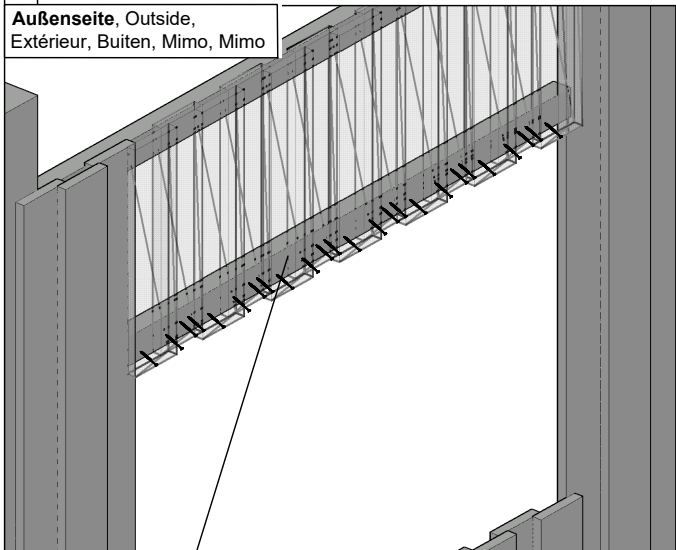

UH4/6, l= 132,5cm
oben bündig mit Ausschnitt, seitlich ausgemittelt,
 flush at top with cut-out, centred at sides / en haut à fleur avec découpe, centré sur le côté / gelijk aan de bovenkant met uitsparing, gecentreerd aan de zijanten / v hornej časti v jednej rovine s výrezom, po stranách vycentrované / nahoře v jedné rovině s výřezem, po stranách vystředěný

je 2x C105-0040, 40mm



Einbau bei Profilschalung

Installation with profiled formwork / Montage pour coffrage profilé / Montage met profielbekisting / Montáž s profilovaným debnením / Instalace s profilovaným bedněním

2.

Innenseite, Inside, Intérieur, Binnen, Vnůtri, Uvnitř

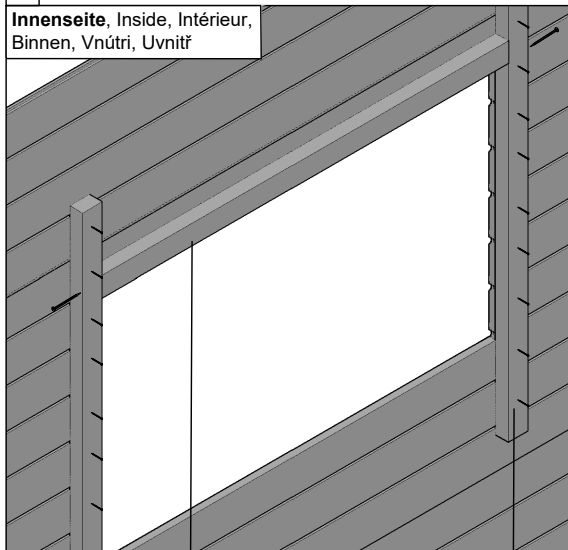

UH4/6, l= 132,5cm
oben bündig mit Ausschnitt, seitlich ausgemittelt, flush at top with cut-out, centred at sides / en haut à fleur avec découpe, centré sur le côté / gelijk aan de bovenkant met uitsparing, gecentreerd aan de zijanten / v hornej časti v jednej rovine s výrezom, po stranách vycentrované / nahoře v jedné rovině s výřezem, po stranách vystředěný

2x C105-0100, 100mm



UH4/6
 l= 120cm
je 9x C105-0050, 50mm



3.

Innenseite, Inside, Intérieur, Binnen, Vnůtri, Uvnitř

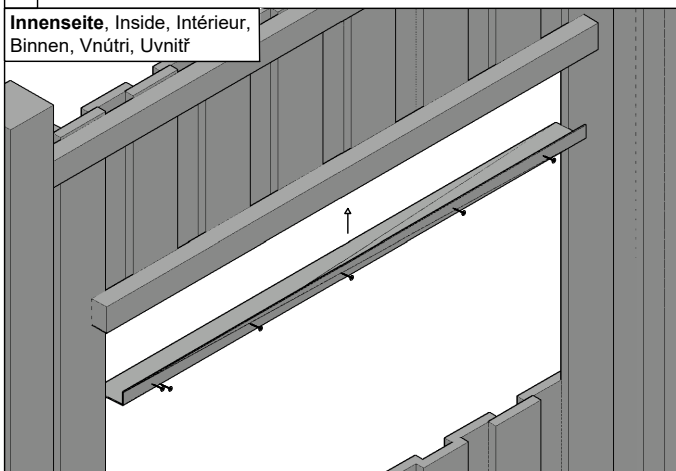

A100-220S

l= 129,4cm

5x C104-0030, 30mm

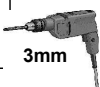

3.

Innenseite, Inside, Intérieur, Binnen, Vnůtri, Uvnitř

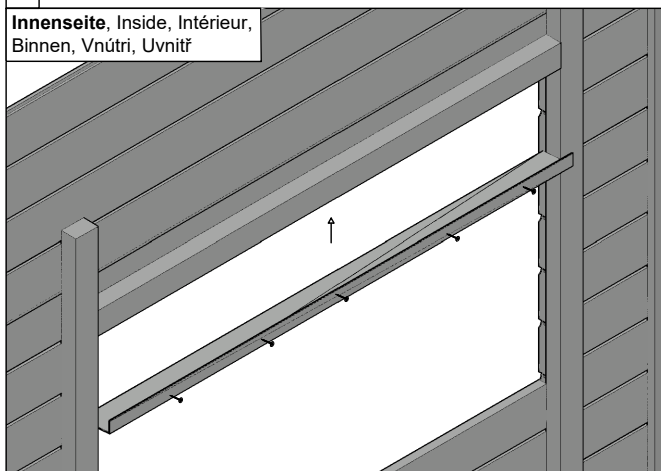

A100-220S

l= 129,4cm

5x C104-0030, 30mm

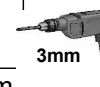

Doppelfenster

Double window / Double fenêtre / Dubbel raam / Dvojité okno



Einbau bei Deckelschalung

Installation with cover formwork / Montage pour coffrage de couvercle / Montage met dekselbekisting / Montáž s krycím debnením / Instalace s krycím bedněním

4.

Innenseite, Inside, Intérieur, Binnen, Vnůtri, Uvnitř

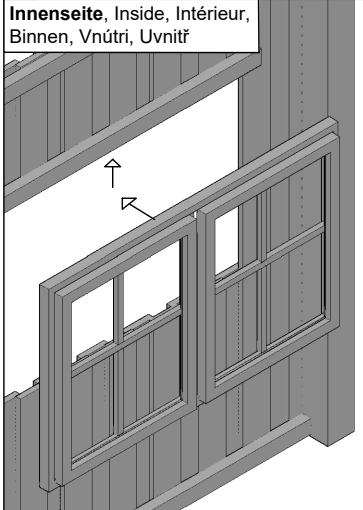

Innenseite, Inside, Intérieur, Binnen, Vnůtri, Uvnitř

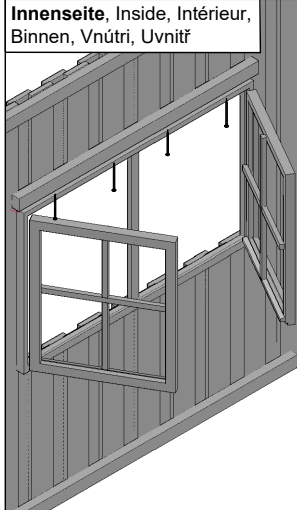

4x C105-0100, 100mm



Einbau bei Profilschalung

Installation with profiled formwork / Montage pour coffrage profilé / Montage met profielbekisting / Montáž s profilovaným debnením / Instalace s profilovaným bedněním

4.

Innenseite, Inside, Intérieur, Binnen, Vnůtri, Uvnitř

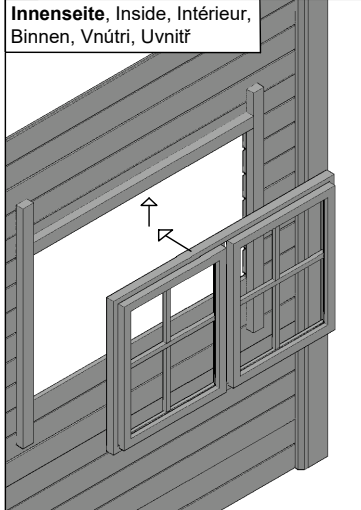

Innenseite, Inside, Intérieur, Binnen, Vnůtri, Uvnitř

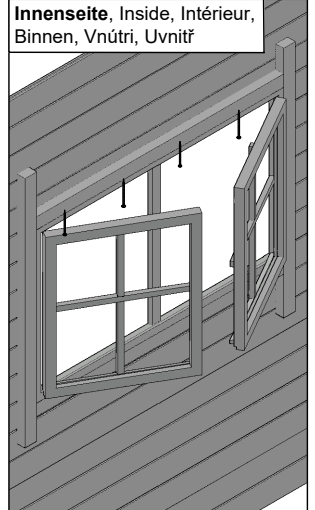

4x C105-0100, 100mm

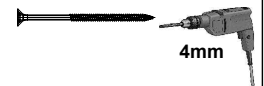

5.

Innenseite, Inside, Intérieur, Binnen, Vnůtri, Uvnitř

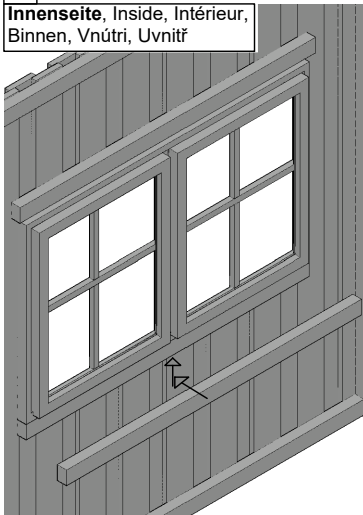

Innenseite, Inside, Intérieur, Binnen, Vnůtri, Uvnitř

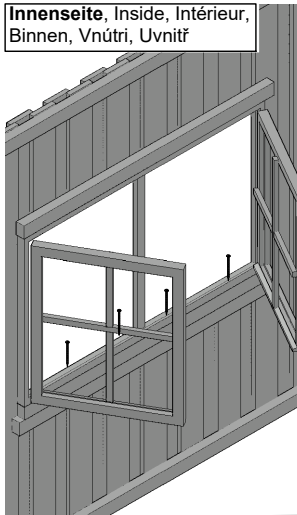

4x C105-0100, 100mm



5.

Innenseite, Inside, Intérieur, Binnen, Vnůtri, Uvnitř

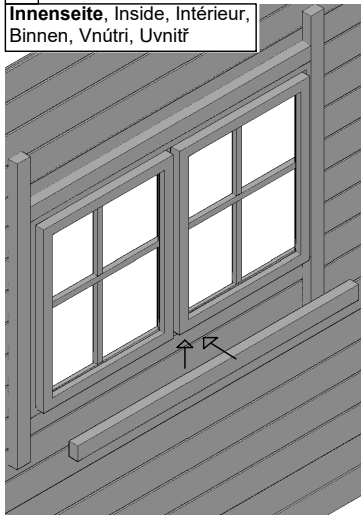

Innenseite, Inside, Intérieur, Binnen, Vnůtri, Uvnitř

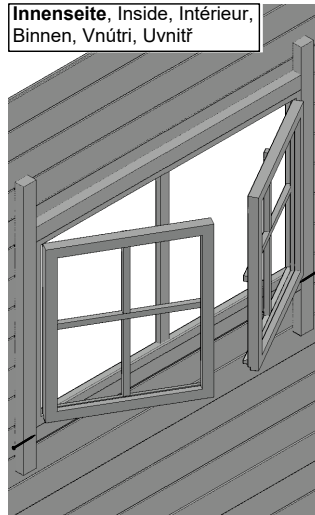

UH4/6, l= 132,5cm
2x C105-0100, 100mm



Doppelfenster

Double window / Double fenêtre / Dubbel raam / Dvojité okno



Einbau bei Deckelschalung

Installation with cover formwork / Montage pour coffrage de couvercle / Montage met dekselbekisting / Montáž s krycím debněním / Instalace s krycím bedněním

6.

Außenseite, Outside, Extérieur, Buiten, Mimo, Mimo

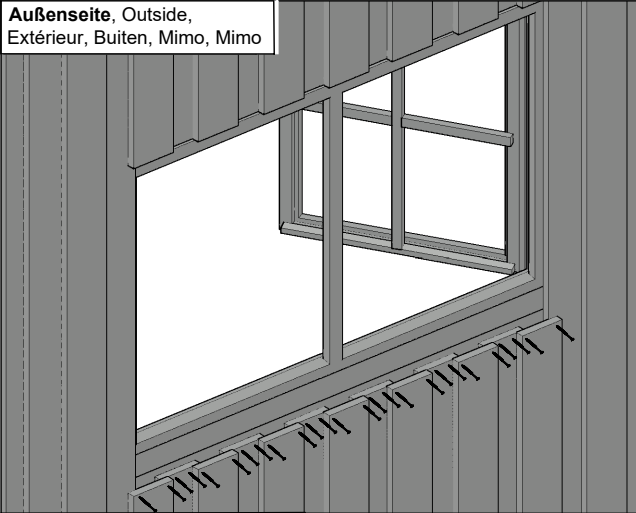

je 2x C105-0040,
40mm

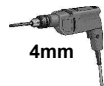

Einbau bei Profilschalung

Installation with profiled formwork / Montage pour coffrage profilé / Montage met profielbekisting / Montáž s profilovaným debněním / Instalace s profilovaným bedněním

6.

Innenseite, Inside, Intérieur, Binnen, Vnůtri, Uvnitř



4x C105-0100, 100mm

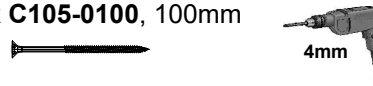

7.

Außenseite, Outside, Extérieur, Buiten, Mimo, Mimo

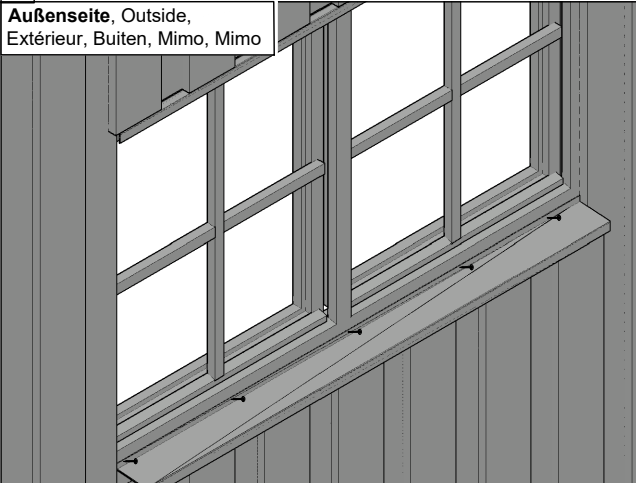

A100-220S
l=129,1cm

5x C104-0030, 30mm



7.

Außenseite, Outside, Extérieur, Buiten, Mimo, Mimo

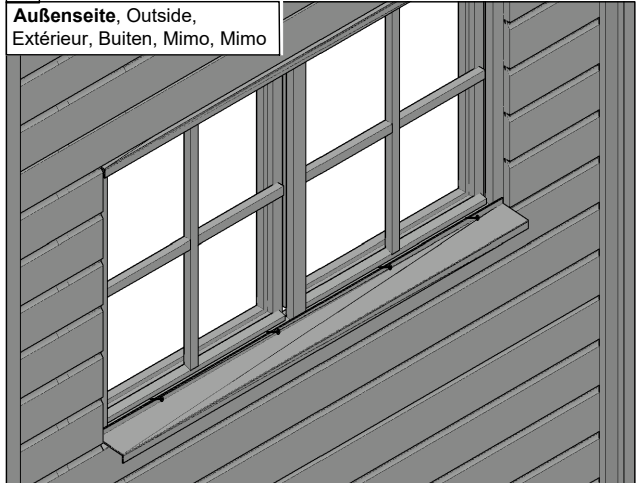

A100-220S
l=129,1cm

5x C104-0030, 30mm

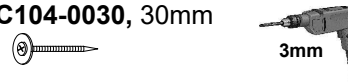

SKAN HOLZ Europe GmbH

Im Alten Dorfe 10

DE-21227 Bendestorf



info@skanholz.com

www.skanholz.com

DE - Bitte sorgfältig lesen und aufbewahren!

EN - Please read carefully and keep in a safe place!

FR - A lire attentivement et à conserver !

ES - Léalo atentamente y guárdelo en un lugar seguro.

IT - Leggere attentamente e conservare in un luogo sicuro!

NL - Lees dit aandachtig door en bewaar het op een veilige plaats!

CZ - Pečlivě si je přečtěte a uschovejte na bezpečném místě!

SK - Pozorne si ju prečítajte a uschovajte na bezpečnom mieste!

FI - Lue huolellisesti ja säilytä turvallisessa paikassa!

NO - Les nøye gjennom og oppbevar på et trygt sted!

SV - Läs noga och förvara på en säker plats!

ET - Palun lugege hoolikalt ja hoidke turvalises kohas!