



www.weka-holzbau.com

14 mm
WANDSTÄRKE

Montage-, Bedienungs- und Wartungsanleitung

en	ASSEMBLY, USER AND MAINTENANCE INSTRUCTIONS
fr	NOTICE DE MONTAGE, D'UTILISATION ET D'ENTRETIEN
it	ISTRUZIONI DI MONTAGGIO, USO E MANUTENZIONE

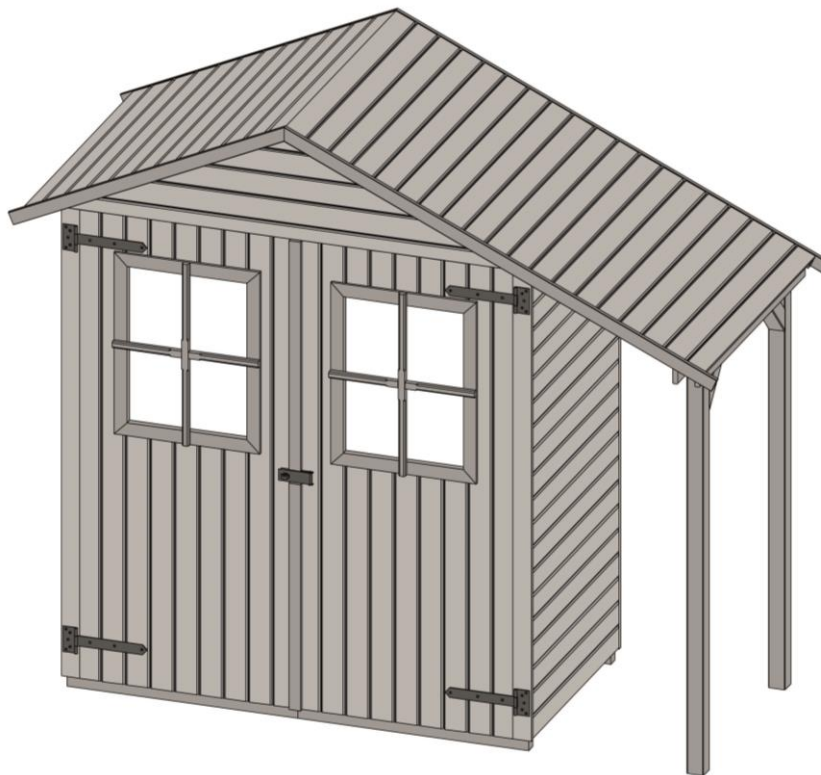

Art.-Nr.: 357.1608.30450

Stand 2438

- de -

Sehr geehrte Kundin, sehr geehrter Kunde,

Lesen Sie diese Anleitung vor dem Aufbau bitte vollständig durch, um Montagefehler oder Beschädigungen zu vermeiden.

WICHTIG !

Prüfen Sie bitte sofort anhand der Packliste, ob das Gerätehaus vollständig und unbeschädigt bei Ihnen angekommen ist.

Bitte vernichten Sie die Packliste erst nach Ablauf der Garantiezeit. Diese Liste dient Ihnen zur Kontrolle auf Vollständigkeit der Einzelteile und ist mit dem Kaufbeleg aufzubewahren. Eventuelle Beanstandungen können mit Hilfe dieser Liste problemlos behoben werden. Die Pos.-Nummern der Packliste stimmen nicht mit den Pos.-Nummern folgender Montageanleitung überein.

Wir empfehlen Ihnen die Montage mit 2 Personen durchzuführen.

Zur Verhütung von Unfällen ist zu vermeiden, daß sich Kinder während der Montage in unmittelbarer Nähe befinden.

Weiterentwicklungen im Sinne des technischen Fortschritts behalten wir uns vor. So können geringfügige Abweichungen in den Darstellungen entstehen.

Die Palette, auf der das Haus transportiert wird, besteht aus zwei Bodenbalken, die zur Montage des Hauses benötigt werden, und zwei Distanzhölzern, welche nur als Verpackungsmaterial dienen und entsorgt werden können.

Verpackungsmaterial nicht einfach wegwerfen! Papier-, Pappe- und Wellpappeverpackungen, sowie Kunststoffverpackungsteile sollten in die entsprechenden Sammelbehälter gegeben werden.

Empfehlungen

Voraussetzung für die fachgerechte Montage ist ein absolut ebenes und rechtwinkliges Fundament.

Wir empfehlen ein Streifenfundament. Einen Fundamentplan erhalten Sie bei Ihrem Fachhändler!

Ein Plattenfundament ist ebenfalls möglich.

Um aufsteigende Feuchtigkeit zu verhindern, empfehlen wir, zwischen dem Fundament und den Bodenbalken eine Sperrschicht aus der Verpackungsfolie, Dachpappe o.ä. zu verlegen.

Die Sperrschicht aus Dachpappe ist nicht im Lieferumfang enthalten.

Die Zwischenräume der Bodenbalken gewährleisten eine notwendige Unterlüftung des Hauses.

Gegen Windschäden ist das Haus mit dem Fundament zu verankern. Hierzu eignen sich im Fachhandel erhältliche Betonanker oder Stahlwinkel, mit denen die Bodenbalken auf dem Fundament befestigt werden.

Die Verankerung gehört nicht zum Lieferumfang.

Die mitgelieferte Dachpappe dient in erster Linie als vorübergehender Schutz gegen

Witterungseinflüsse. Um einen dauerhaften Schutz zu gewährleisten, empfehlen wir Ihnen die Dacheindeckung *nur* mit besandeten Bitumenschindeln. Damit schaffen Sie die Grundlage für eine lange Haltbarkeit und Widerstandsfähigkeit gegen Witterungseinflüsse. Andernfalls ist mit Schäden an Ihrem weka-Produkt zu rechnen.

Bitte bohren Sie alle Schraubverbindungen vor, um Beschädigungen an den Holzteilen zu vermeiden!

Folgendes Zeichen macht Sie während der Anleitung nochmals darauf aufmerksam:

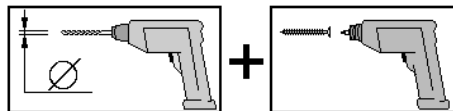

Holzschutz

Schützen Sie unbehandeltes Holz vor und während des Aufbaus vor direkter Sonneneinwirkung oder Feuchtigkeit!

Das Produkt besteht aus dem natürlichen Rohstoff Holz. Dies macht regelmäßig ausreichende Holzschutzmaßnahmen zwingend erforderlich. Für die fachgerechte Holzschutzbehandlung wenden Sie sich bitte an einen Holzschutzfachmann.

Holzschutzmaßnahmen sind vom Kunden in eigener Verantwortlichkeit durchzuführen. Ohne vorschriftsmäßigen Holzschutz kann keine Gewährleistung übernommen werden. Bitte beachten Sie auch die diesbezüglichen Bestimmungen in unseren Garantieerklärungen.

Wir wünschen Ihnen viel Freude mit Ihrem Holzprodukt.

Tür und Fenster sind von außen sowie von innen mit der Holzschutzlasur zu behandeln.

Die Bodenbalken wurden bereits von uns ausreichend vorbehandelt (kesseldruckimprägniert).

Ein regelmäßiger Anstrich gemäß der Herstellerangaben der Holzschutzlasur ist zum Schutz des Holzes notwendig.

Werkzeug

Folgendes Werkzeug sollten Sie vor Beginn des Aufbaus zurechtgelegt haben:

Wasserwaage Rollmaß Bohrmaschine Elektroschrauber Stecheisen Schraubenschlüssel

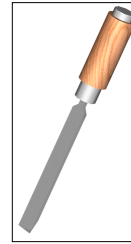
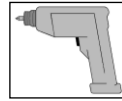
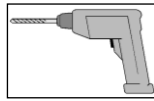
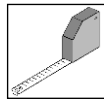

SW 10

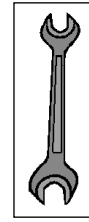

Feinsäge /
Handkreissäge

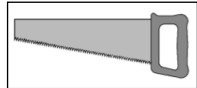

Universalmesser

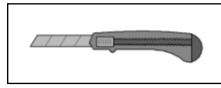

Schnur

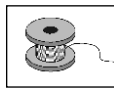

Hammer



Abkürzungen:

cm	-	Zentimeter
mm	-	Millimeter
ca.	-	circa
RW	-	Rückwand

- en -

Dear customer

Read these instructions through completely before assembling your product in order to avoid errors in assembly or damage.

IMPORTANT

Please use the enclosed packing list to check immediately that your Engine house has been delivered complete and intact.

Please do not dispose of the packing list before the guarantee period has expired. This list enables you to check that all the individual parts are present. It should be retained along with the proof of purchase. Any complaints which may arise can probably be easily rectified with this list. The item numbers on the packing list do not correspond to the item numbers in the following assembly instructions.

We recommend that 2 people carry out the assembly.

In order to prevent accidents, we recommend that children are kept out of the direct vicinity during assembly.

We reserve the right to make further technological developments. This means that there may be minor deviations in the illustrations.

The pallet on which the structure is transported comprises 2 floor beams which are required for the assembly of the structure and 2 distance timbers which are only packaging material and can be disposed of.

Please do not simply throw away the packaging material. Paper, card and corrugated board as well as plastic packaging materials should be placed in the correct collection containers.

Recommendations

A prerequisite for successful assembly is an absolutely level and square foundation. We recommend a continuous foundation.

A foundation plan can be obtained from your specialist dealer.

A raft foundation is also possible.

In order to avoid rising damp, we recommend that a barrier layer using the packaging film, roofing paper or similar be laid between the foundation and the floor beams.

Roofing paper for a barrier layer is not included in the scope of this delivery.

Fit the wall boards together, with the tongue pointing upwards. If necessary, use a rubber mallet, where the assembly timber will prevent any damage to the tongue. The assembly timber can be found in the front wall package.

The structure should be anchored to the foundation to protect against wind damage. Concrete anchors or steel angles obtainable from specialist suppliers are suitable for anchoring the floor beams to the foundation. The anchors are not included in the scope of this delivery.

The roofing felt provided serves primarily as a temporary protection against the weather. To ensure lasting protection we recommend you to cover the roof *only* with sanded bitumen shingles.

This creates the basis for a long life and resistance to the influences of the weather. Otherwise damage to your weka product is to be expected.

Please drill pilot holes for all screw connections to avoid damaging the wood. The following symbol in the instructions will indicate when this is necessary:

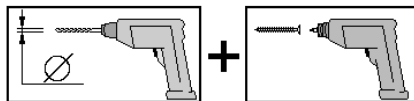

Wood protection

Before and during assembly, protect untreated wood from direct sunlight or moisture.

The product is made from natural timber, for which regular and adequate wood preservation measures are obligatory. Please contact a wood preservation expert for information on professional preservation measures.

Wood preservation is to be carried out by the customer at his own risk. No guarantee can be given in the event of wood preservation not carried out in accordance with the instructions. Please also note the provisions relating to this in our guarantee. We wish you much pleasure with your wood product.

Doors and windows are to be treated both inside and outside with the wood protection agent.

The floor beams have already been adequately treated by us (boiler pressure impregnated).

A regular coating in accordance with the manufacturer's instructions of the wood protection agent is necessary to protect the wood.

Tools

You should have the following tools to hand before beginning assembly.

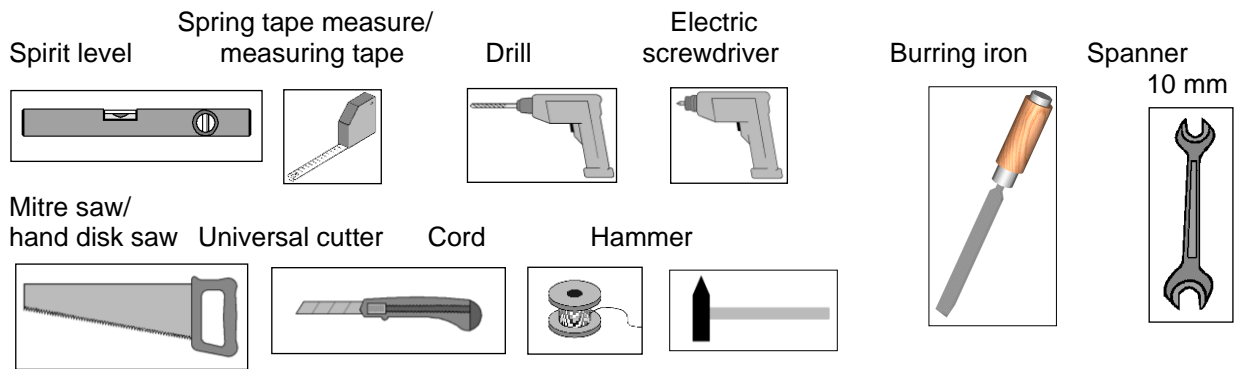

Abbreviations / Symbols:	cm	-	Centimetre
	mm	-	Millimetre
	ca.	-	approximately/approx.
	RW	-	Rear wall

- fr -

Chère Cliente, cher Client

Lisez entièrement la présente notice avant de procéder à l'assemblage afin d'éviter les erreurs et les dommages.

IMPORTANT !

Veillez vérifier immédiatement, à l'aide de la liste des pièces, si le remise est arrivé complet et en bon état.

Ne détruisez la liste des pièces qu'une fois la garantie écoulee. Cette liste vous permet de vérifier si les pièces détachées sont complètes et doit être conservée avec le justificatif d'achat. Elle vous permettra de faire valoir aisément d'éventuelles réclamations. Les numéros de pos. de la liste des pièces ne sont pas identiques aux numéros de pos. de la présente notice de montage.

Nous vous recommandons d'effectuer le montage à 2 personnes.

Afin de prévenir tout accident, éviter la présence d'enfants à proximité durant le montage.

Nous nous réservons le droit d'apporter aux produits des modifications dans le cadre de l'évolution technique.

De légères différences sont par conséquent possibles par rapport aux illustrations.

La palette sur laquelle est transportée la maison se compose de deux solives qui sont nécessaires pour le montage de la maison et de deux lattes d'écartement qui servent uniquement à l'emballage et qui peuvent être éliminées.

Ne pas jeter simplement le matériel d'emballage! Les emballages en papier, carton et carton ondulé doivent être déposés dans le container de tri correspondant.

Recommandations

Une fondation parfaitement plane et d'équerre est indispensable pour un montage dans les règles. Nous recommandons une fondation sur semelle.

Un plan de fondation vous sera remis par votre revendeur!

Une fondation en table est également possible.

Afin d'éviter les remontées d'humidité, nous recommandons de placer entre la fondation et les solives une couche composée du film d'emballage, de carton bitumé ou autre.

La couche d'arrêt en carton bitumé n'est pas fournie.

L'espacement des solives assure la nécessaire circulation de l'air sous la maison.

Afin de prévenir les dommages dus au vent, ancrer l'abri sur la fondation en fixant les solives à la fondation avec des pièces d'ancrage pour béton ou des équerres en acier du commerce.

Les pièces d'ancrage ne sont pas fournies.

Le carton bitumé fourni sert en premier lieu de protection temporaire contre les intempéries. Afin de garantir une protection durable, nous vous recommandons de procéder à la couverture *uniquement* avec des bardeaux bitumés sablés. Vous ferez ainsi le nécessaire pour conférer à votre produit une grande longévité et résistance aux intempéries. A défaut, vous risquez fortement d'endommager votre produit weka.

Pré-percez tous les assemblages vissés afin d'éviter d'endommager les éléments en bois!

Ceci vous est rappelé par le symbole suivant dans la notice:

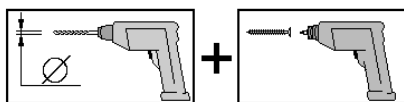

Protection du bois

Protégez le bois non traité du soleil et de l'humidité avant et durant le montage!

Cet article est en bois brut naturel. Il est impératif d'entretenir et de protéger le bois régulièrement. Veuillez vous renseigner auprès d'un spécialiste du bois pour connaître les traitements appropriés.

Les mesures de protection du bois sont à effectuer par le client, sous sa propre responsabilité. Aucune garantie ne peut être accordée si le bois n'a pas été protégé selon les règles. Veuillez également vous reporter aux dispositions correspondantes de nos déclarations de garantie.

Nous vous souhaitons beaucoup de plaisir à l'usage de votre article en bois.

Traiter l'extérieur et l'intérieur de la porte et de la fenêtre avec la lasure protectrice.

Les solives sont déjà traitées d'origine (traitement en autoclave).

La lasure protectrice doit être appliquée de manière régulière conformément aux instructions du fabricant pour assurer la protection du bois.

Outils

Pour le montage, nous vous recommandons de préparer les outils suivants.

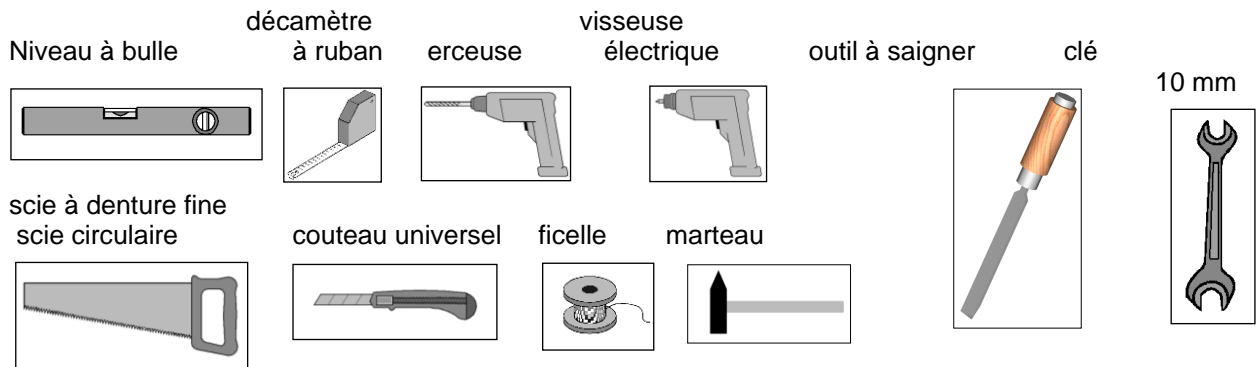

Abréviations / Symboles:	cm	-	centimètres
	mm	-	millimètres
	ca.	-	environ / env.
	RW	-	paroi arrière

- it -

Egregi clienti,

Prima del montaggio leggete con cura le presenti istruzioni al fine di evitare errori di montaggio o danni.

IMPORTANTE !

Controllate subito con l'ausilio della lista di imballaggio che il baracca attrezzisia stato fornito completo e senza danni.

Vi preghiamo di conservare la lista di imballaggio solo alla scadenza del periodo di garanzia. Questa lista serve per controllare la completezza della fornitura e deve essere conservata insieme allo scontrino. Con l'ausilio della lista è possibile risolvere eventuali reclami. I numeri di posizione della lista di imballaggio non corrispondono con i numeri di posizione delle seguenti istruzioni di montaggio.

Raccomandiamo di eseguire il montaggio in 2 persone.

Per scongiurare eventuali incidenti tenere lontano i bambini dal luogo di montaggio.

Ci riserviamo di apportare modifiche ai fini del progresso tecnologico. Per tale motivo è possibile che nelle rappresentazioni vengano a crearsi lievi differenze.

Il pallet sul quale viene trasportata la casetta è formato da due traverse di pavimento che serviranno per il montaggio della casa e da due travi distanziali che servono solo come materiale di imballaggio e che possono essere smaltite.

Non gettare via il materiale di imballaggio! La carta, il cartone normale e ondulato cosiccome gli imballaggi in plastica devono essere smaltiti negli appositi contenitori di raccolta.

Raccomandazioni

Per un corretto montaggio è assolutamente necessario che le fondamenta siano piane e perpendicolari.

Raccomandiamo un fondamento a striscia.

Per uno schema delle fondamenta rivolgetevi al vostro rivenditore specializzato!

È possibile però anche utilizzare un fondamento a piastre.

Per evitare la salita di umidità raccomandiamo di posare uno strato di sbarramento in plastica, in cartone catramato etc. fra le fondamenta e le traverse del pavimento. Lo strato di sbarramento in cartone catramato non è contenuto nella fornitura.

Gli interstizi fra le travi di pavimento garantiscono la necessaria ventilazione della casetta.

Per evitare danni in caso di tempesta o forte vento la casa deve essere ancorata alle fondamenta. A tal fine è sufficiente utilizzare i comuni elementi di ancoraggio da calcestruzzo o angolari in acciaio con cui fissare le traverse del pavimento alle fondamenta. L'ancoraggio non è compreso nella fornitura.

Il cartone catramato fornito serve in primo luogo come protezione provvisoria contro le intemperie. Per garantire una protezione duratura, consigliamo la copertura del tetto con *solo* tegole canadesi bituminose sabbiate. In questo modo create le basi per una lunga durata e resistenza alle intemperie. In caso contrario, potranno verificarsi dei danni al vostro prodotto weka.

Per evitare danni agli elementi in legno si raccomanda di preforare tutti i punti di avvitaggio a vite! Il presente simbolo richiama la vostra attenzione su tale particolare nel corso delle istruzioni:

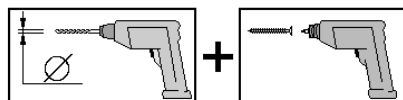

Protezione legno

Protegete il legno non trattato o naturale prima e durante il montaggio dai raggi solari diretti o dall'umidità!

Il prodotto è composto dalla materia prima naturale del legno che rende le misure di protezione del legno assolutamente necessarie. Per il trattamento di protezione del legno a regola d'arte rivolgersi ad un esperto di protezione del legno.

Le misure di protezione del legno devono essere eseguite dal cliente sotto la sua responsabilità. Senza protezione del legno prescritta non può essere assunta nessuna garanzia. Osservare anche le disposizioni al riguardo nelle nostre dichiarazioni di garanzia.

Vi auguriamo un buon utilizzo del nostro prodotto legno.

Anche la porta e le finestre devono essere verniciate con la velatura sia internamente che esternamente. Le traverse del pavimento sono già sufficientemente pretrattate in fabbrica (impregnazione a pressione).

Per proteggere il legno è necessario stendere uno strato di velatura ad intervalli regolari come prescritto dal produttore.

Utensile

Prima di iniziare con il montaggio tenere a portata di mano i seguenti utensili.

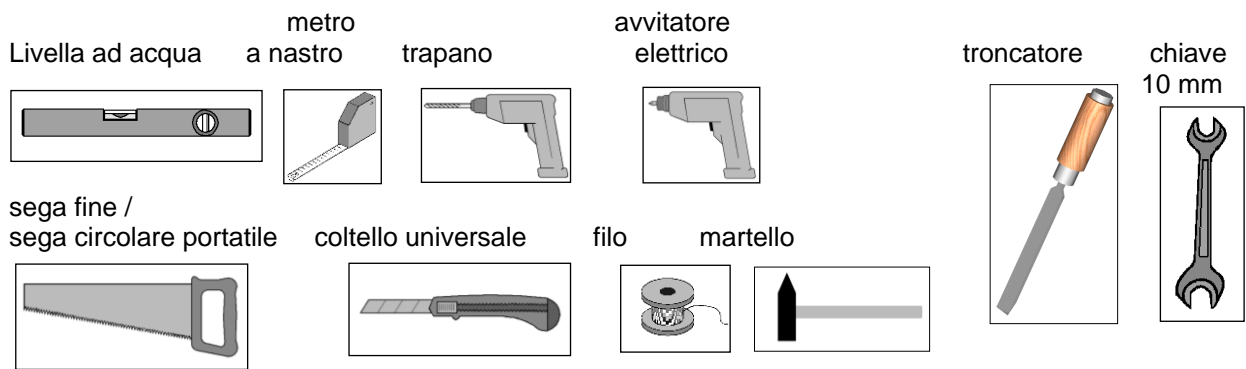







Abkürzungen:

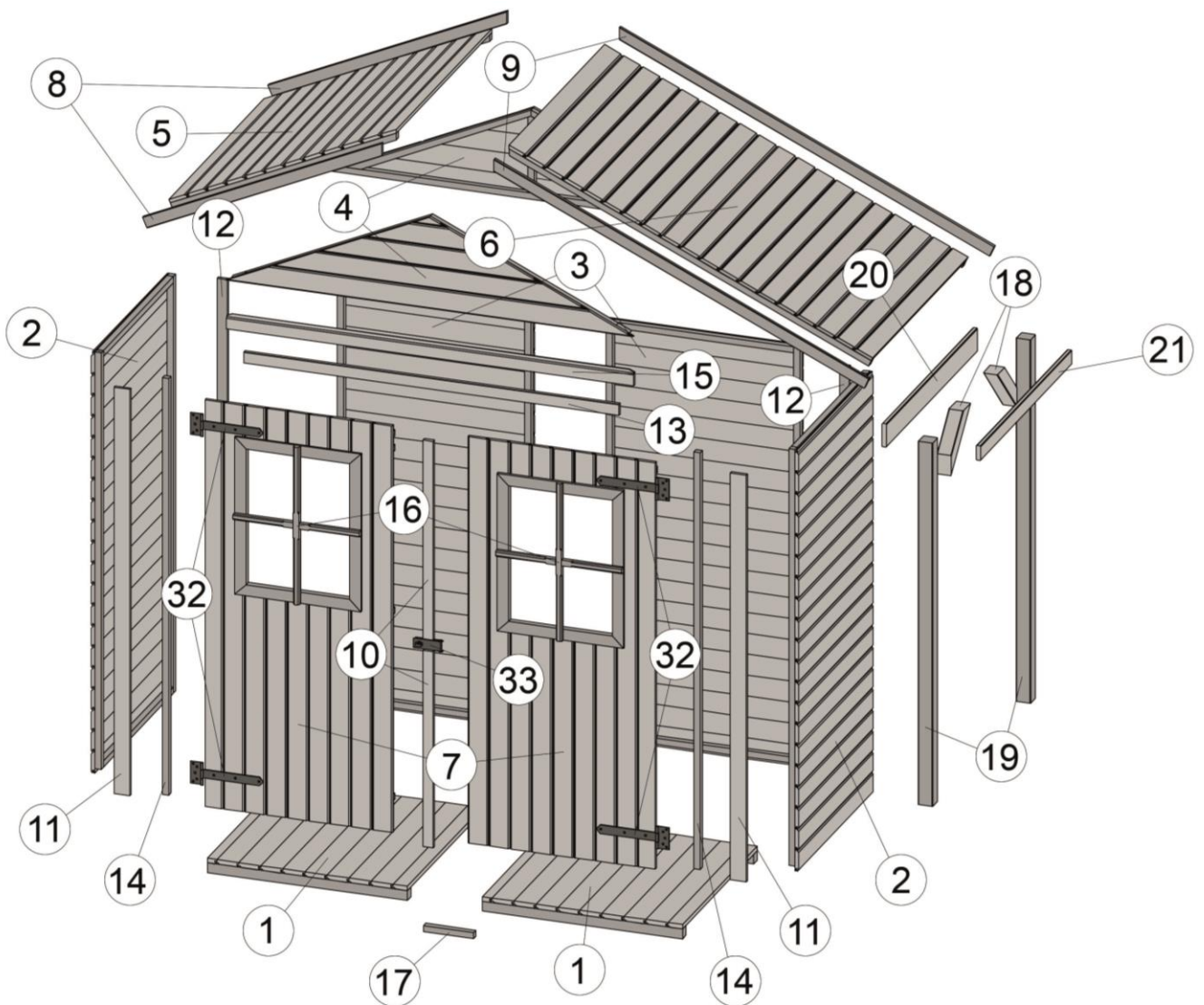

cm	-	centimètres
mm	-	Millimetri
ca.	-	circa / ca.
RW	-	parete posteriore



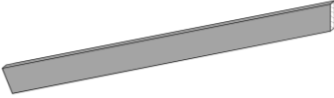
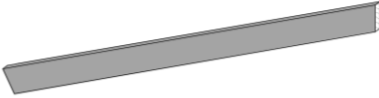
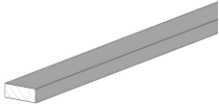

Übersicht

en	Overview
fr	vue d'ensemble
it	panoramica

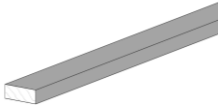

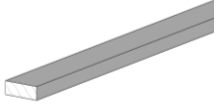
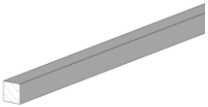
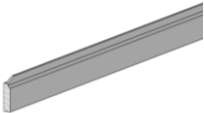





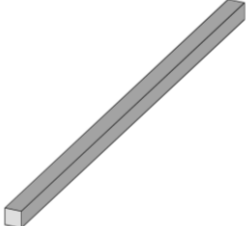
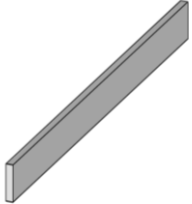
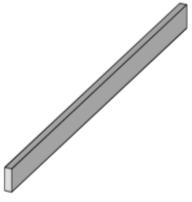
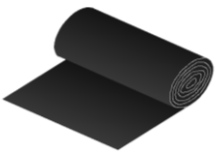
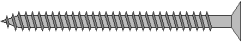
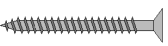

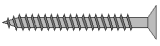
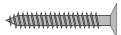
Pos	Bild	Abmessung	Stück
①	B361.01.0001 	820 x 800	2
②	B351.01.0014 	820 x 1710	2
③	B351.01.0015 	775 x 1710	2
④	B351.02.0058 	1628 x 373	2
⑤	B357.01.0001 	1050 x 1000	1
⑥	B357.01.0002 	1050 x 1595	1

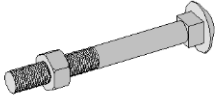
Pos	Bild	Abmessung	Stück
7	B351.03.0007 	750 x 1650	2
8	G357.01.0001 	15 / 45 / 1050	2
9	G357.01.0006 	15 / 45 / 1645	2
10	G351.01.0026 	15 / 40 / 1650	1
11	G351.01.0027 	14 / 64 / 1650	2
12	G357.01.0004 	15 / 40 / 1702	2

Pos	Bild	Abmessung	Stück
13	G357.01.0003 	15 / 45 / 1500	1
14	G357.01.0005 	25 / 25 / 1691	2
15	G357.01.0002 	14 / 62 / 1628	1
16	C357.01.0001 	505 x 640	2
17	G351.04.0004 	25 / 25 / 200	2
18	G351.01.0032 	58 / 58 / 300	2

Pos	Bild	Abmessung	Stück
19	G300.10.0001 	58 / 58 / 1700	2
20	G351.01.0034 	18,5 / 96 / 1000	1
21	G351.01.0035 	18,5 / 60 / 1000	1
22		1,2 x 1,0m	3
23		4,5 x 70	4
24		4,0 x 60	25

Pos	Bild	Abmessung	Stück
25		4,0 x 40	55
26		3,5 x 35	100
27		3,5 x 25	25
28		3,5 x 16	20
29		M6 x 60	8
30		6,4	8

Pos	Bild	Abmessung	Stück
31		2,0 x 13	125
32		250mm	4
33			1
34			2

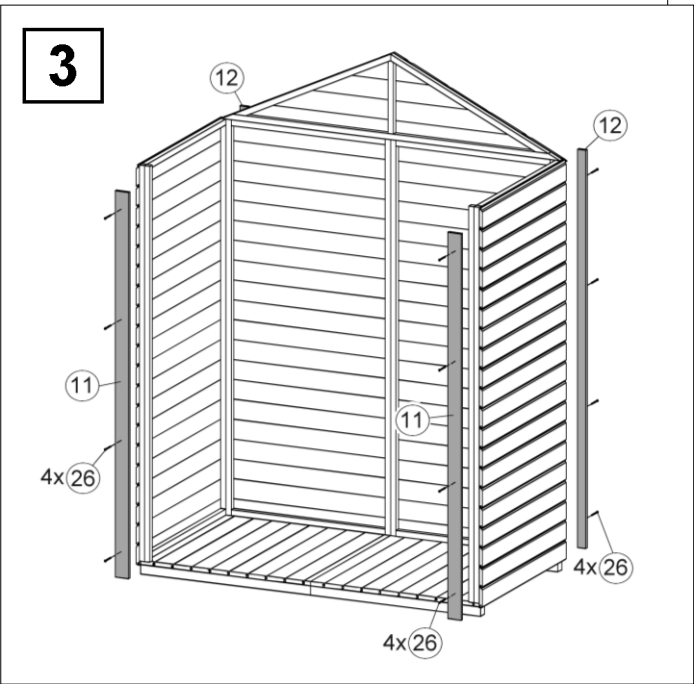
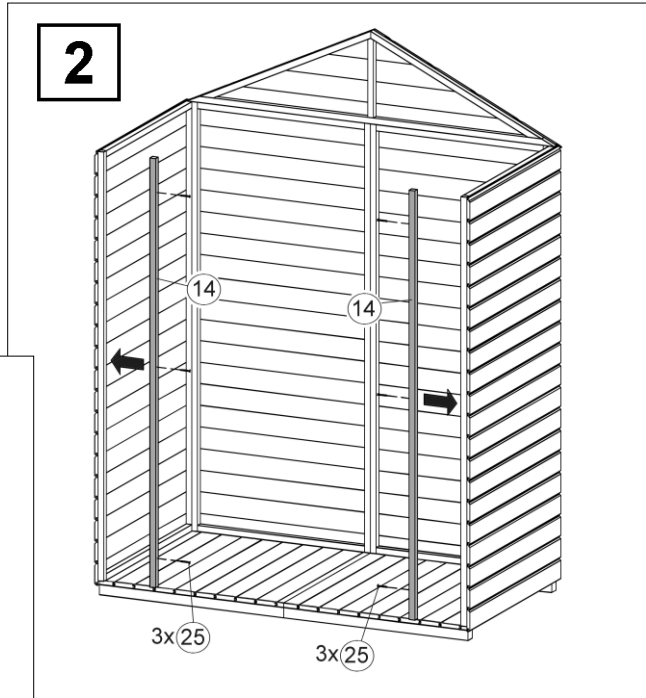
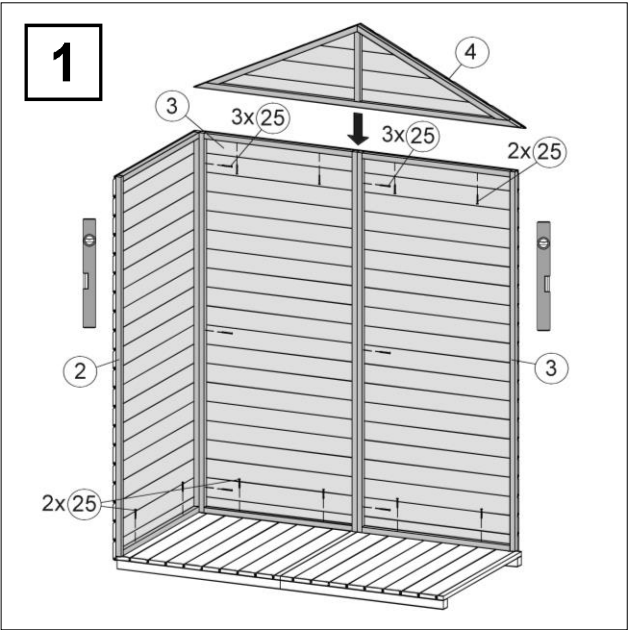
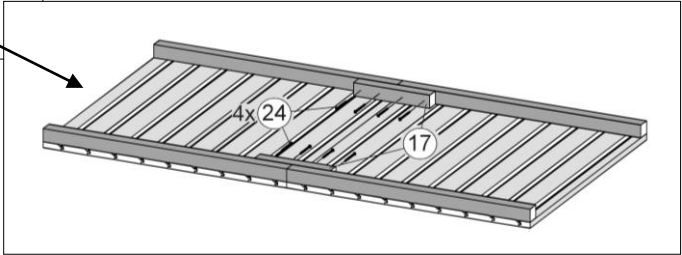
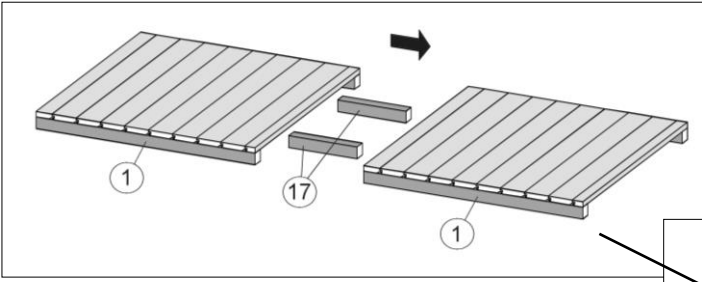

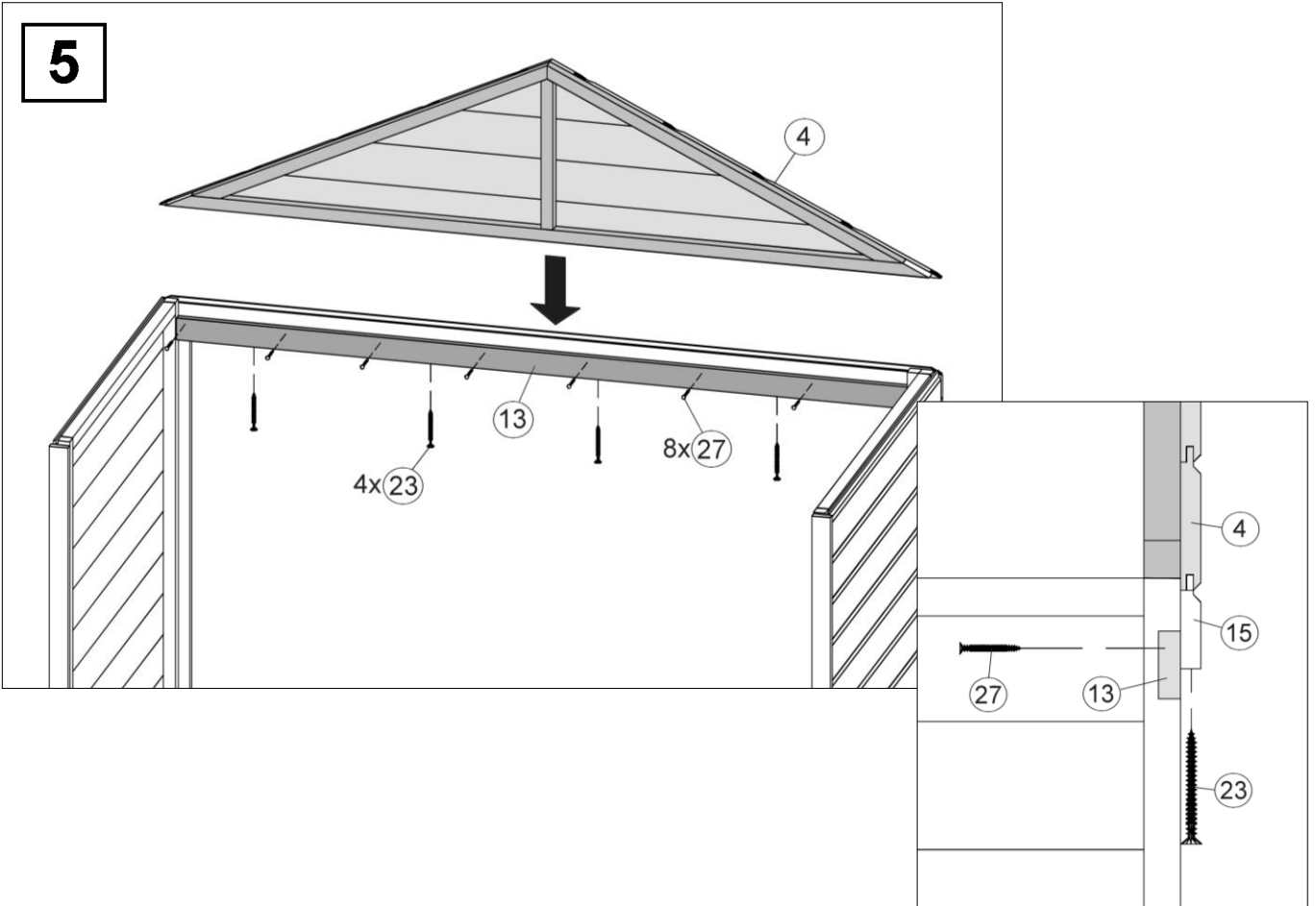
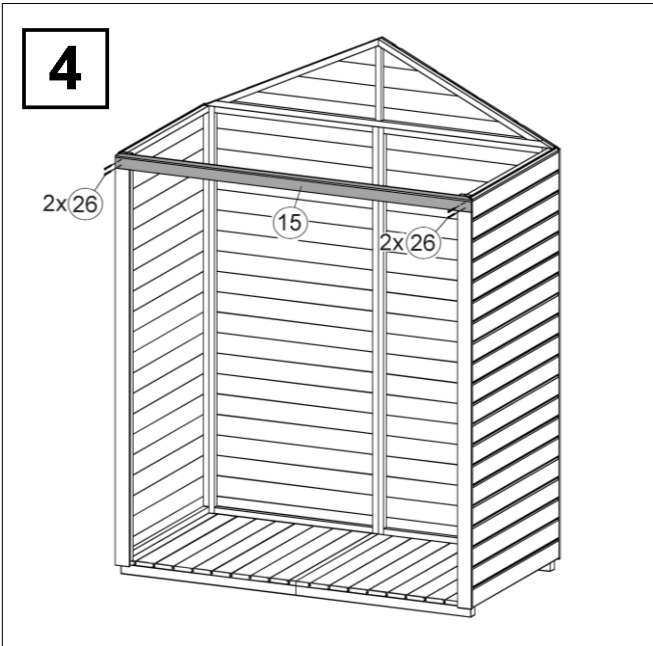
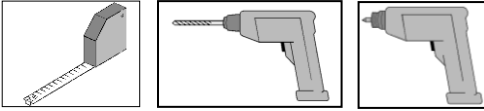

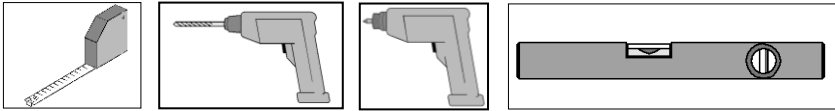

6

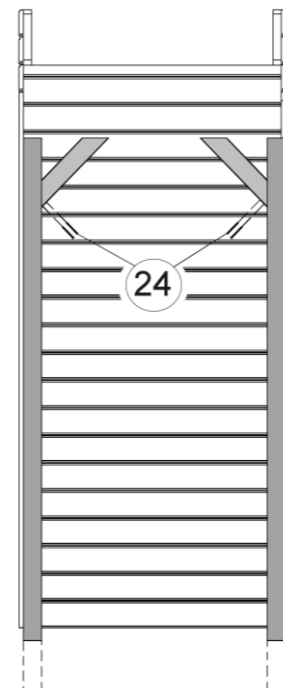
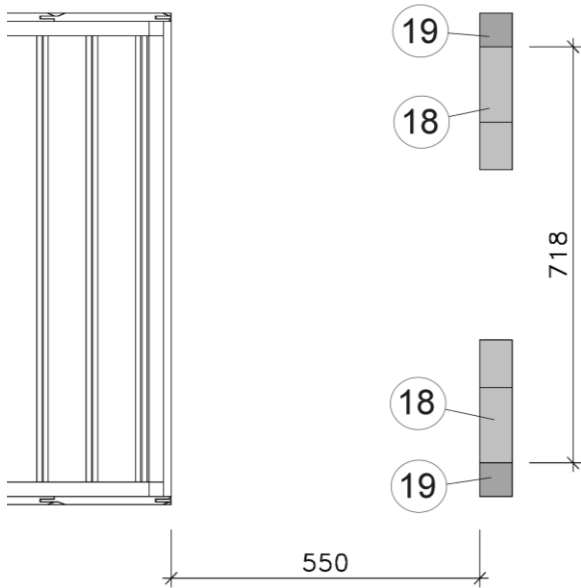
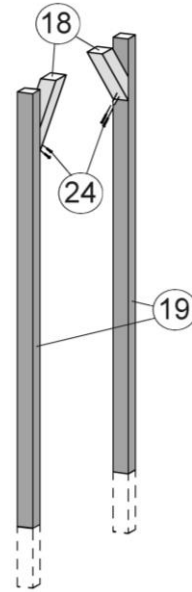
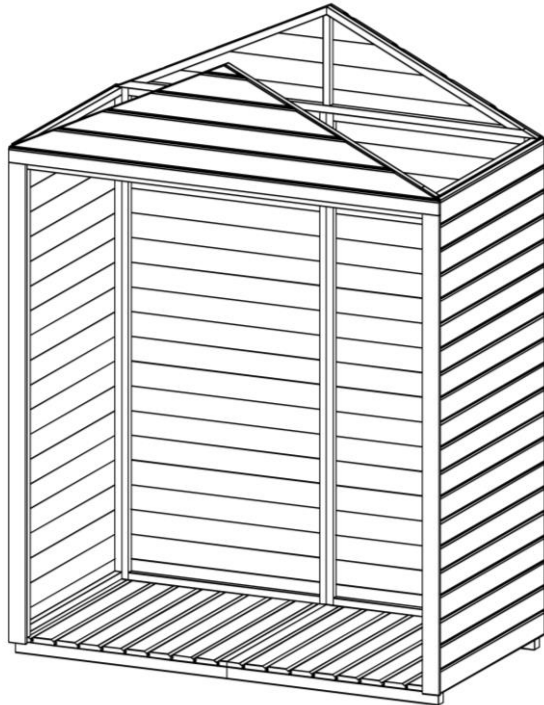

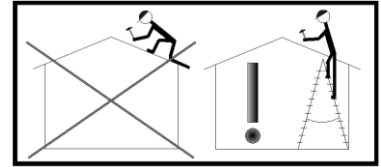
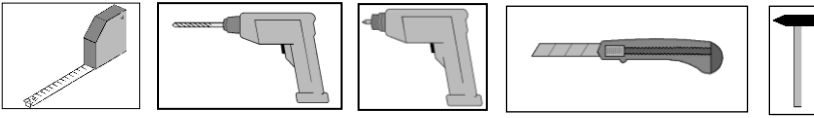

7

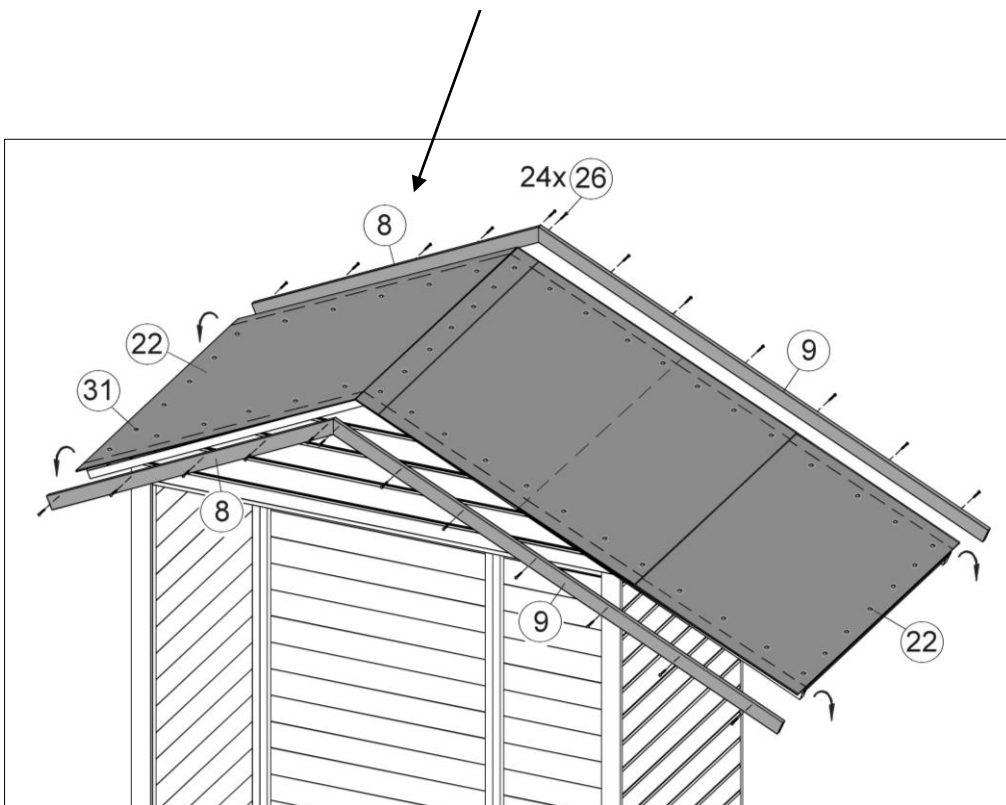
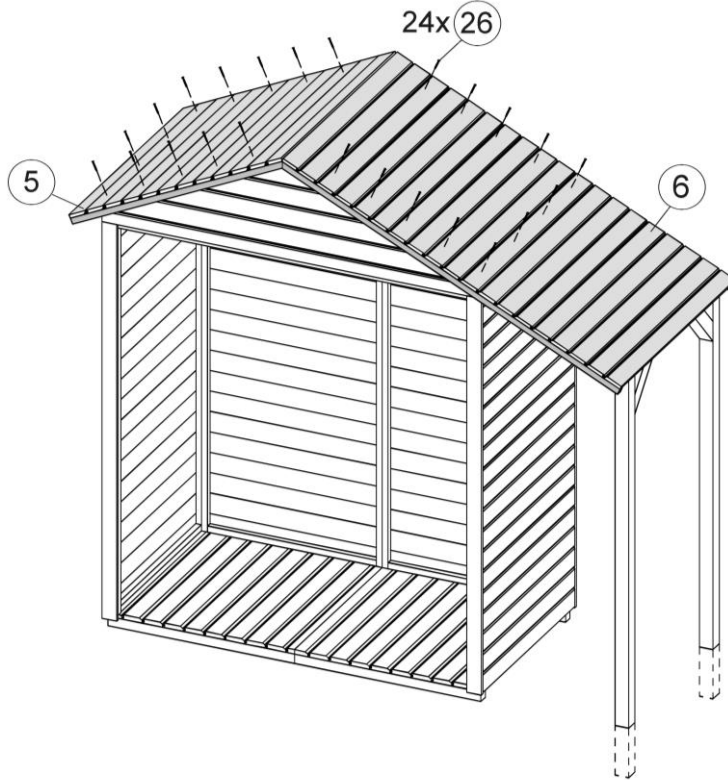

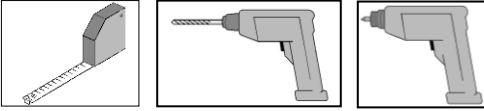

8

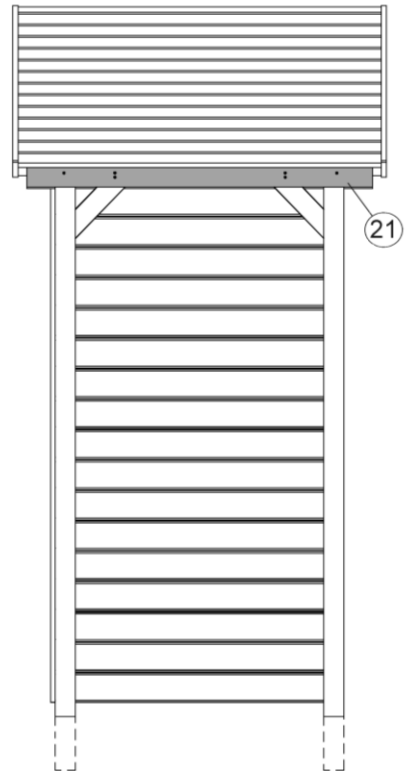
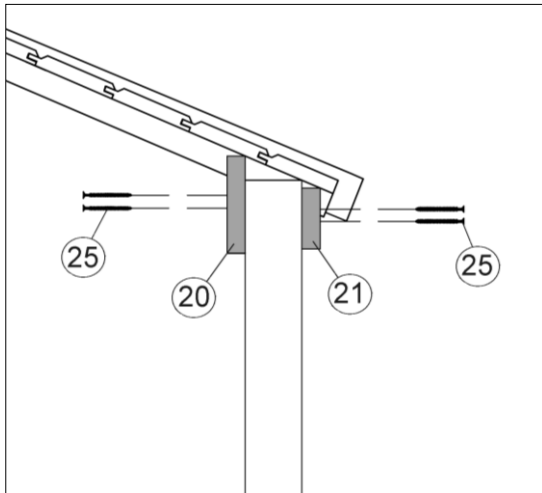
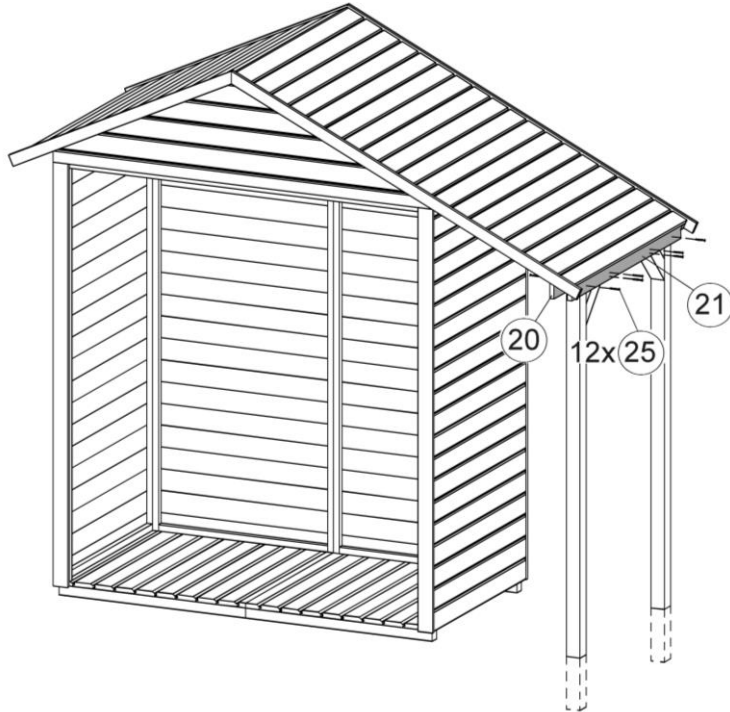

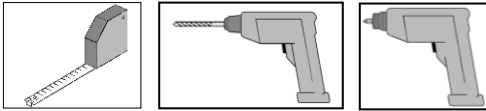

9

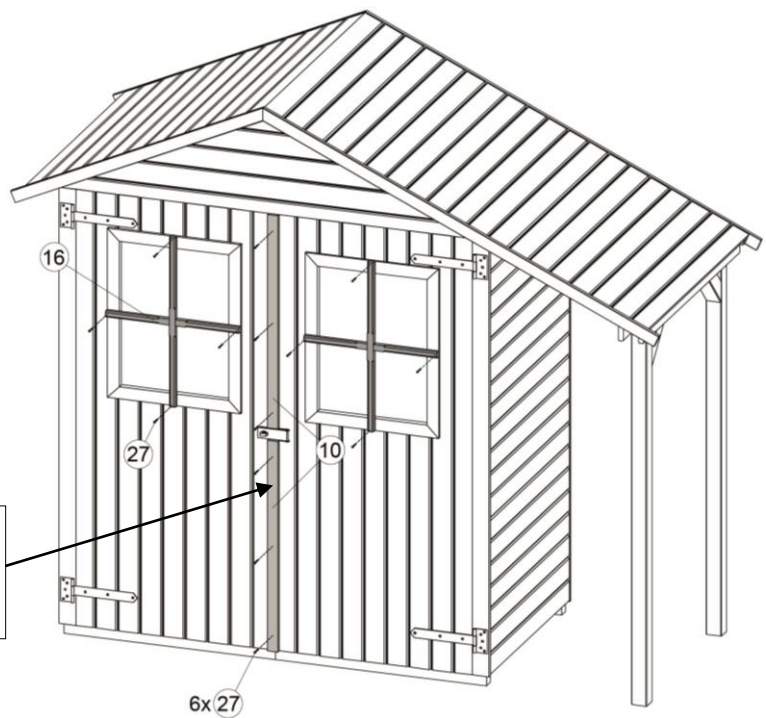
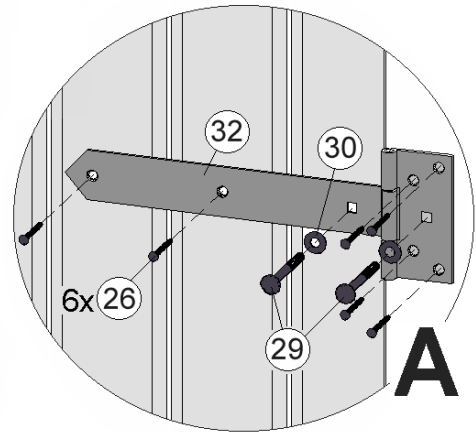
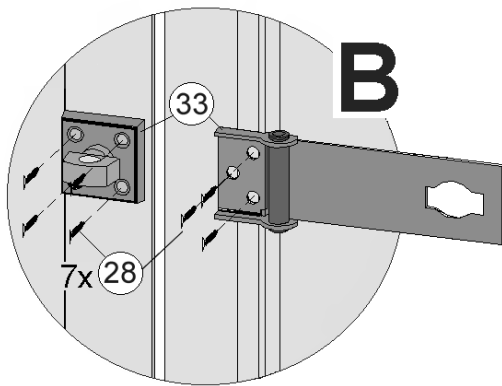
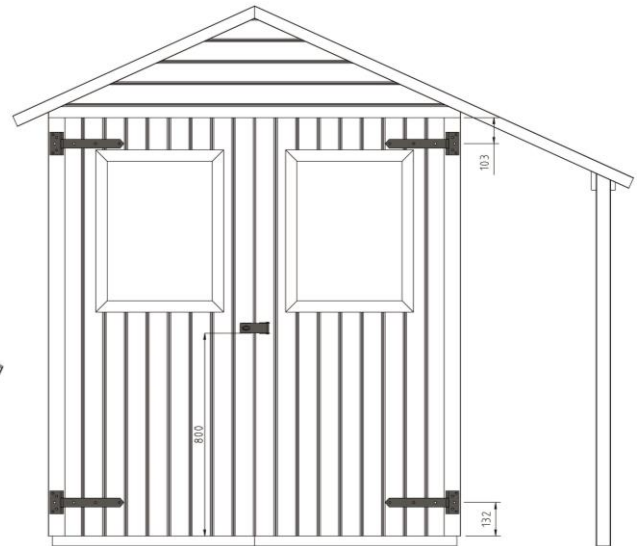
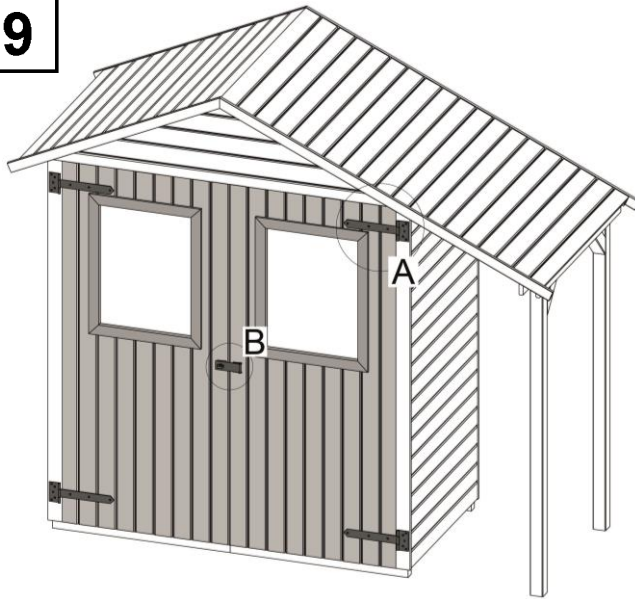

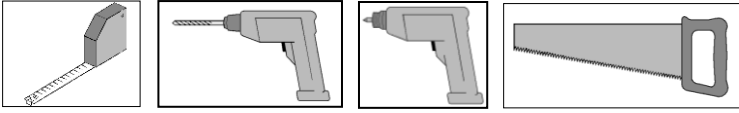

10

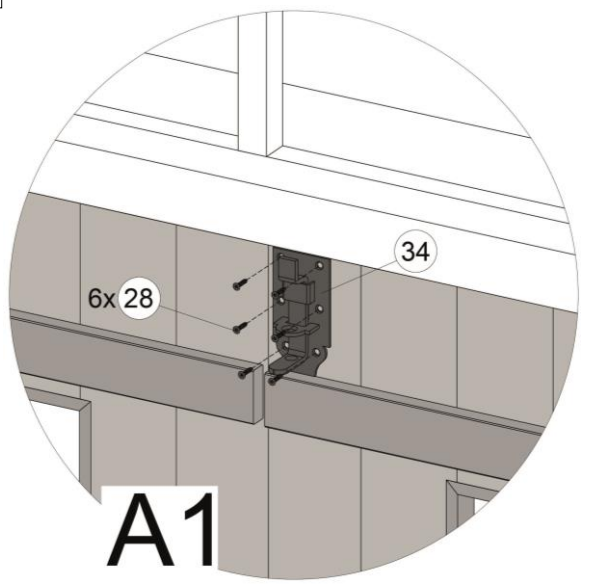
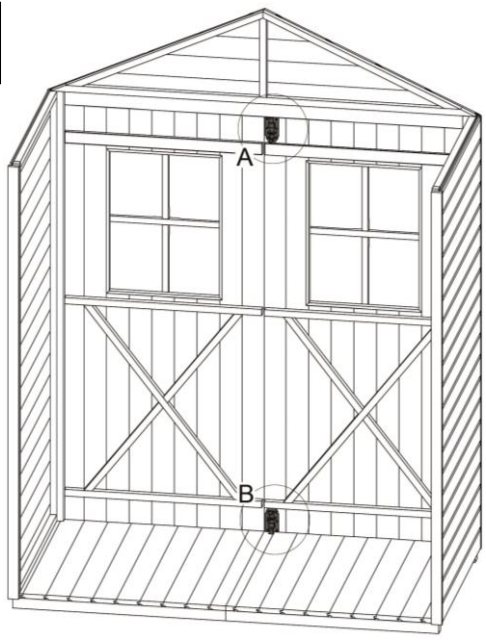

A1

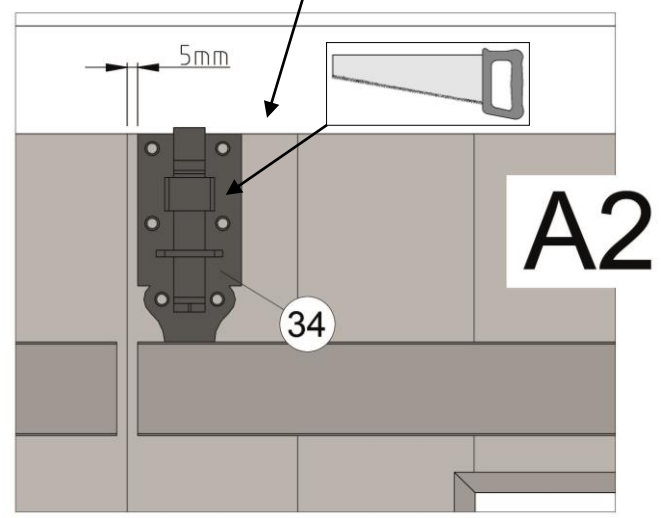

A2

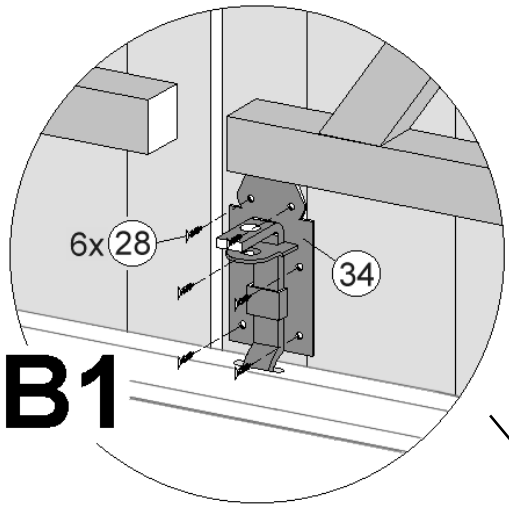

B1

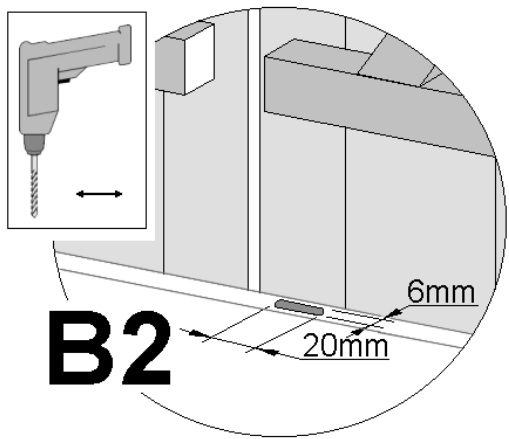

B2



weka Holzbau GmbH,
Johannesstr. 16
D-17034 Neubrandenburg
Tel.: 0395 42908-0
Fax: 0395 42908-83

MA Art.-Nr.: 800.0286.17.36