



Safety Instructions

1,2,3,4,5,6,7,10,12,13,16,19,
20,22,24,28,33,34



Art.-Nr.: 924.66
924.67
924.68
924.70

(+MA326) PSPU 11/22



924.66
924.67
924.68

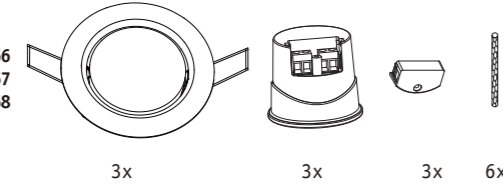

924.70

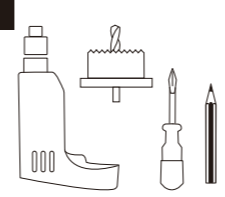
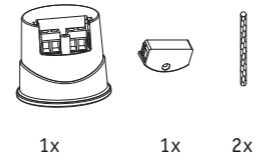

Paulmann Licht GmbH
Quezinger Feld 2
31832 Springe
Germany
www.paulmann.com

31.08.2021 01.09.2021
ENERGIA 874/2012 A++ - A
ENERGIA 2019/2015 F

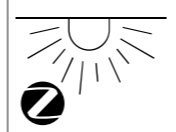
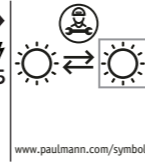

Factory Reset



Factory Reset

5x off \rightarrow on \rightarrow Flash 10x \checkmark

OR

Factory Reset

1 <1s + <1s 2 <1s
P <1s 3 <1s Flash 2x \checkmark



not incl.
Remote Control
Art.-Nr.: 500.67

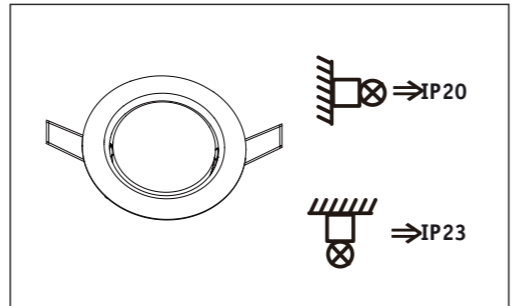
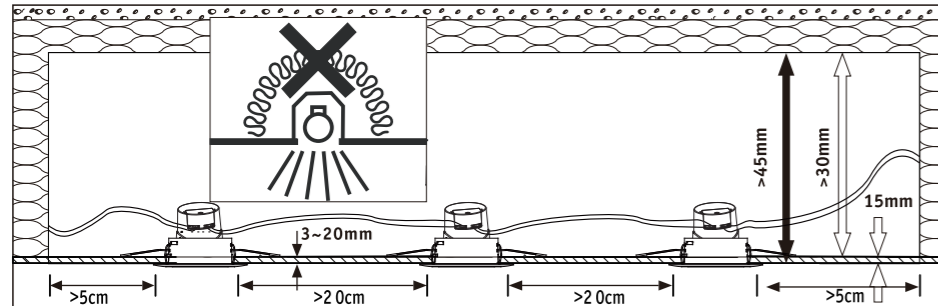

A

Nr.7

(\varnothing 68-73mm)

B

Safety Instructions Nr.5

C

Parallellable

D

E

F

G

H

OK

Add more Functions



www.paulmann.com/zb



not incl. Gateway

Zugelassen für den Betrieb in allen Ländern der EU / Approved for operating in all European countries
CE: Konform mit / in accordance with / conformance a 2014/53/EU <http://www.paulmann.com/ce>

2,4 GHz - 2,4835 GHz



Doesn't apply for the geographical area within a radius of 20km from the centre on "Ny Alesund"

Hiermit erklärt Paulmann Licht, dass der Funkanlagentyp [924.66_924.67_924.68_924.70] der Richtlinie 2014/53/EU entspricht. Der vollständige Text der EU-Konformitätserklärung ist unter der folgenden Internetadresse verfügbar: www.paulmann.com/ce Funk-Frequenz [2,4 GHz - 2,4835 GHz] Abgestrahlte Energie [10 mW]

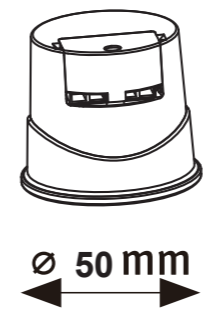

420 lm
4.9 W
230 V

warm white
3000 K

CRI/Ra \geq 80

\approx 25x
1.000h

ON OFF \geq 50.000

Lumen 60% <2 s



390092470

