



Nilfisk



128336070

Kornmarksvej 1|DK-2605 Brøndby|Denmark|Tel.: (+45) 4323 8100

Quick Start Guide - Premium 180 / Premium 190

Caution: Read the instructions before using the machine

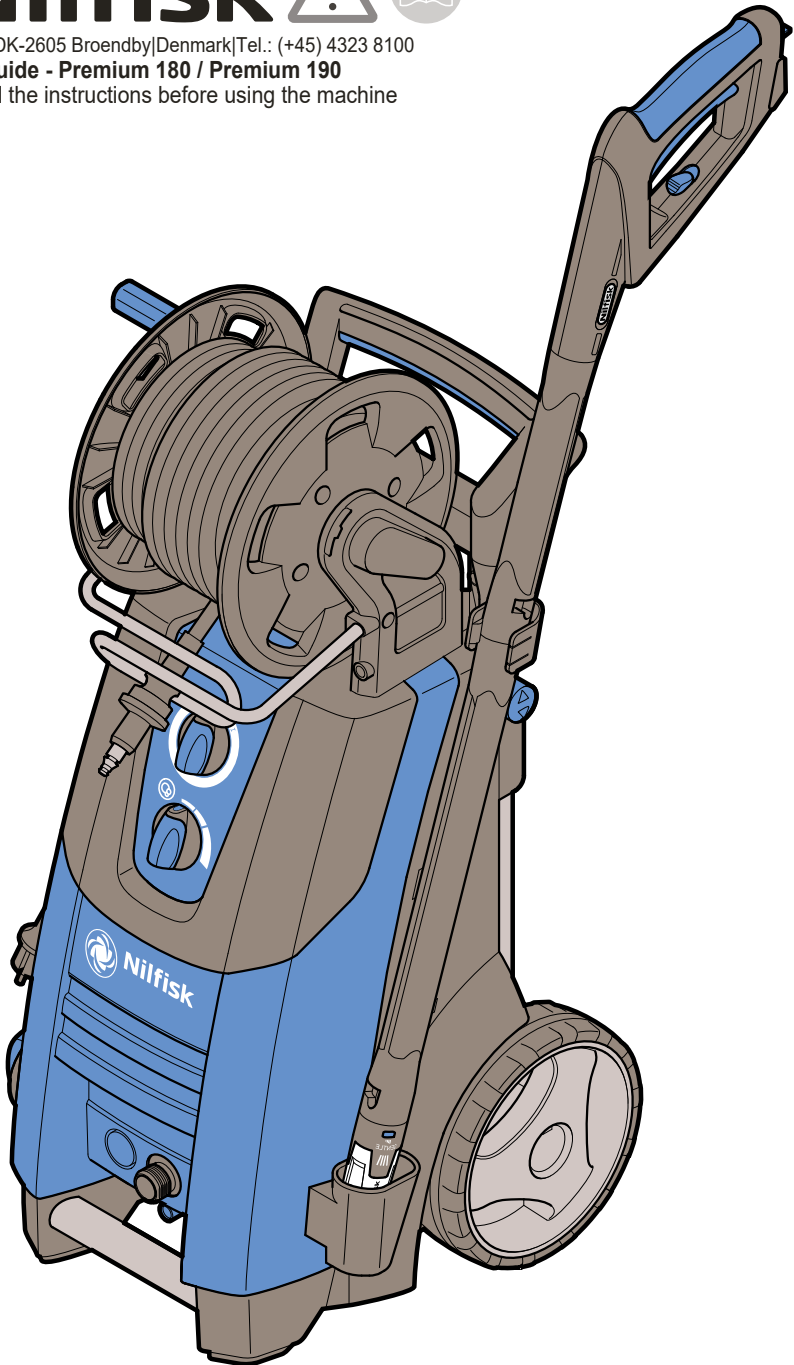

Premium 180 / Premium 190

A



1

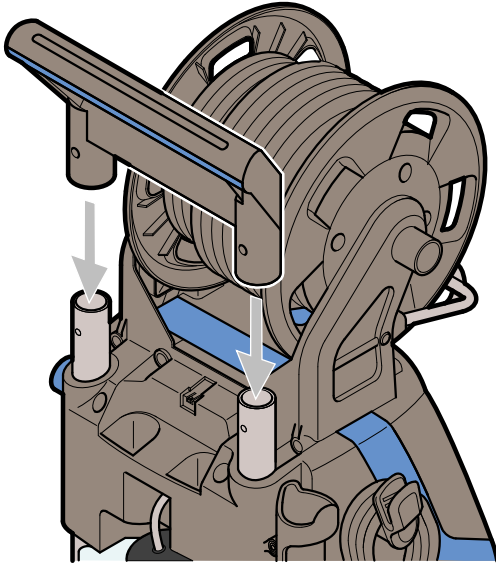

2

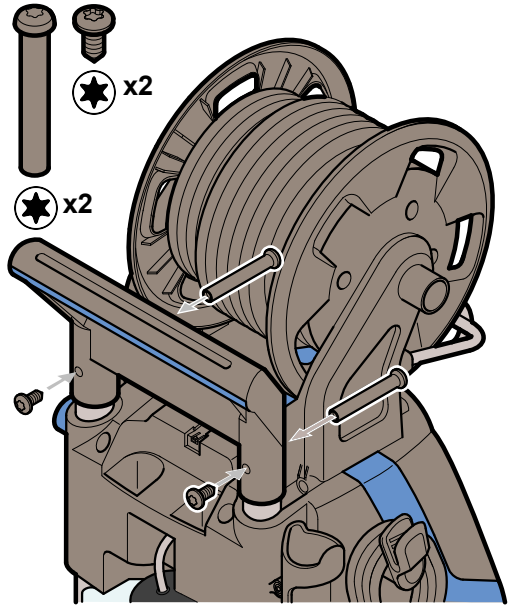

3

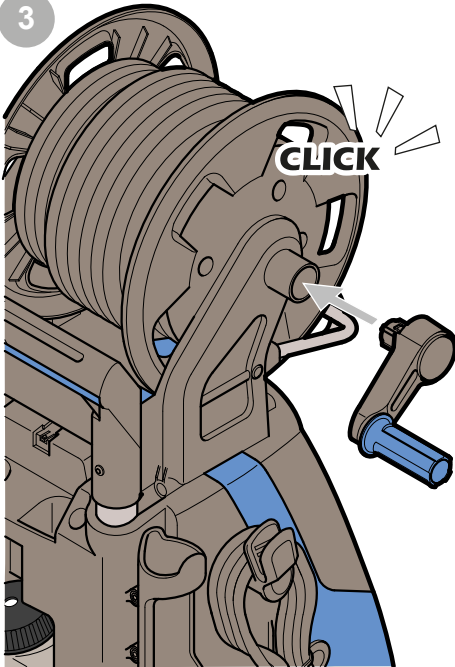

4

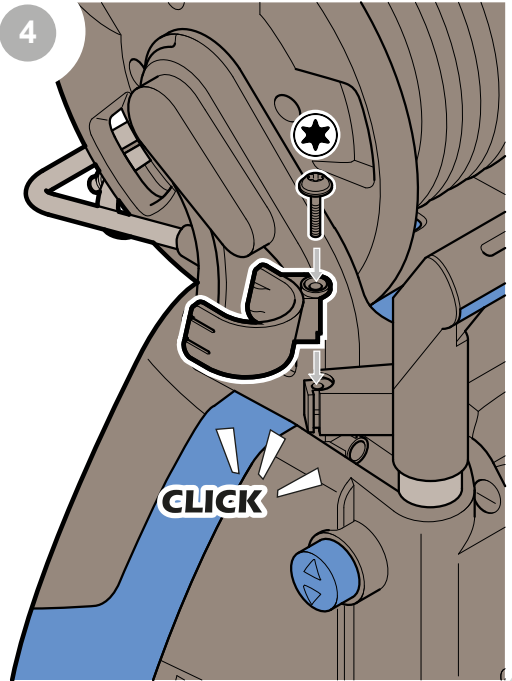

A

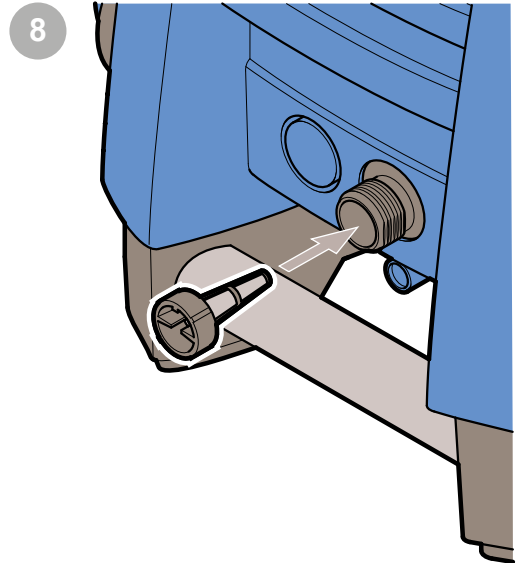
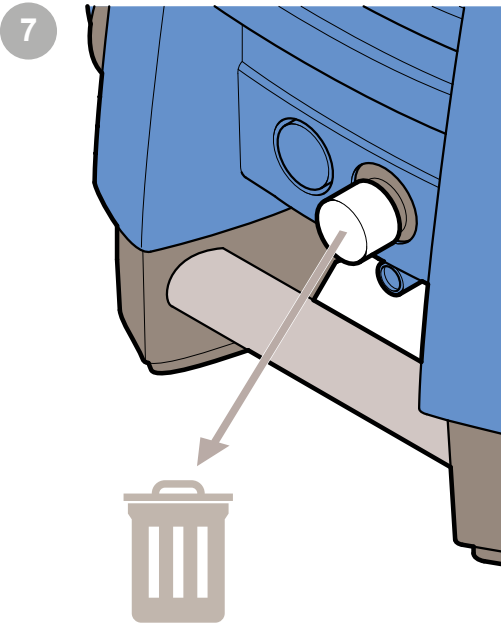
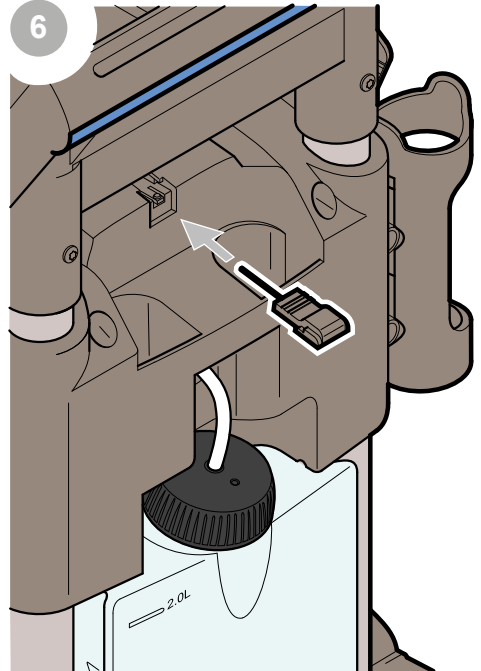
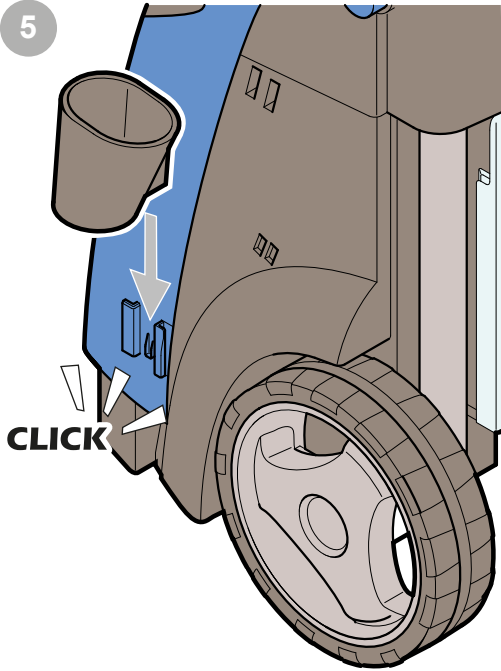

A



9

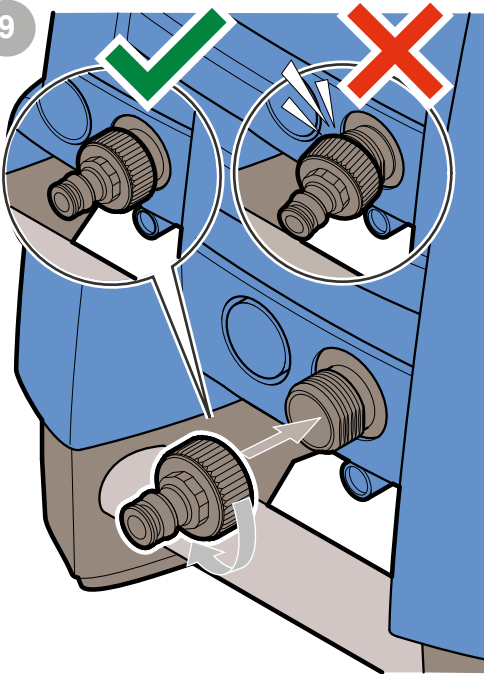

10

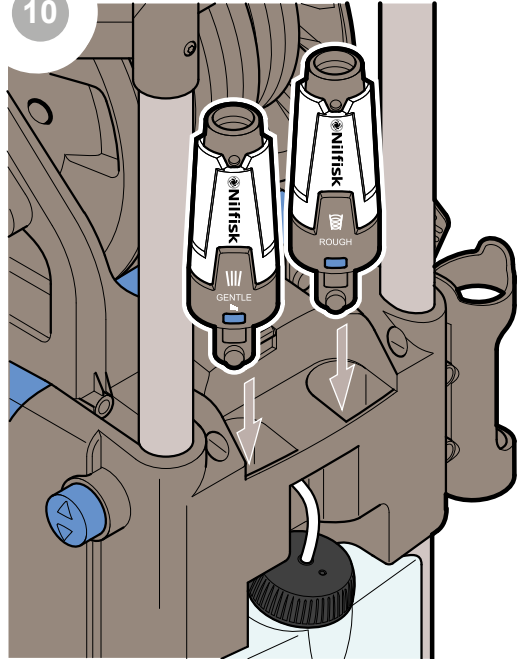

11

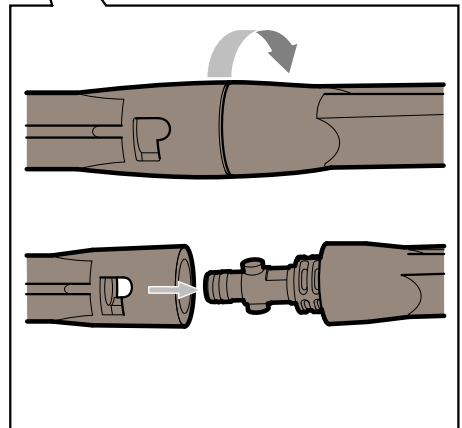
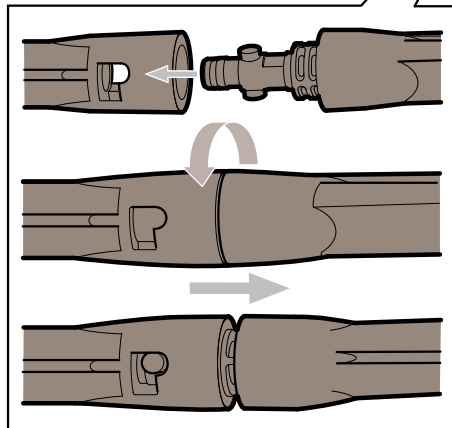
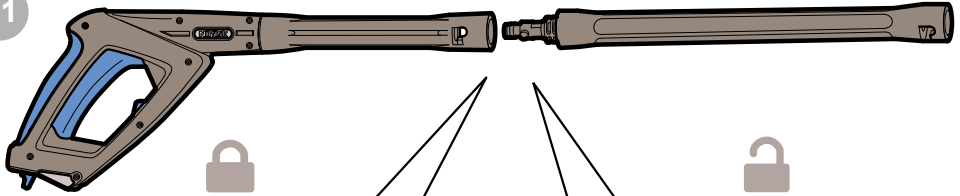



12

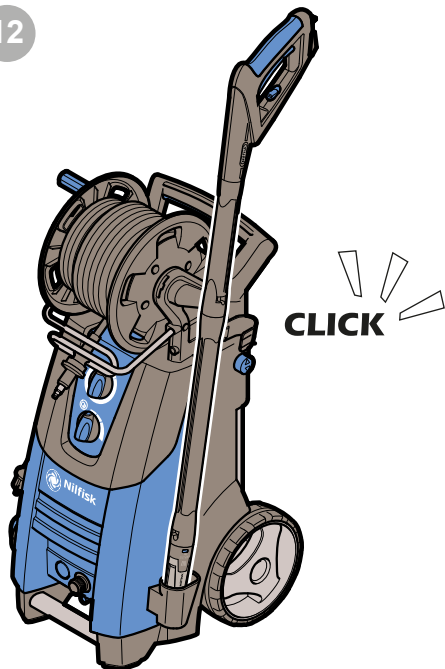

13

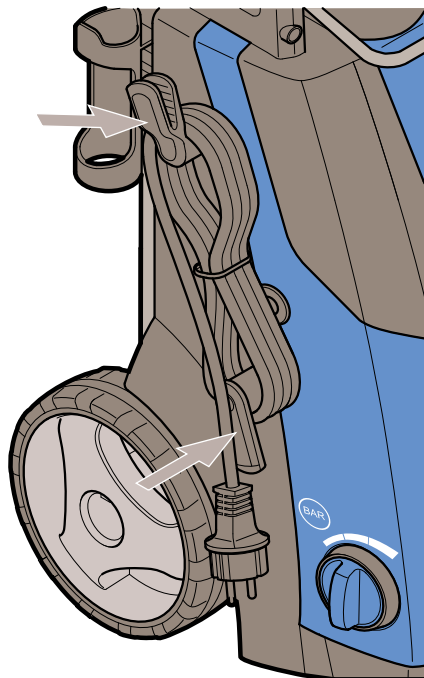

B



1

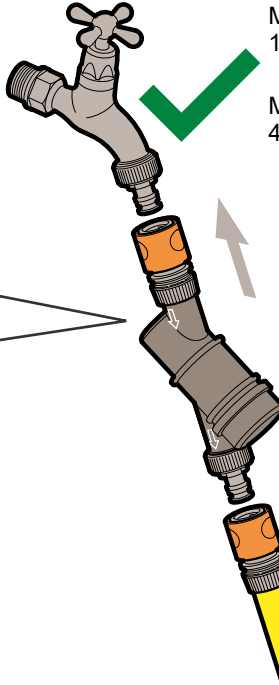
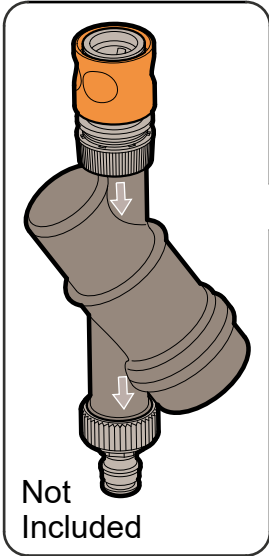

MAX
1 MPa/10 bar

MAX
40°

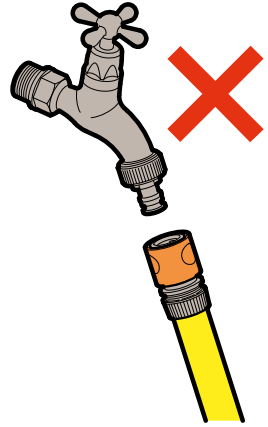

2

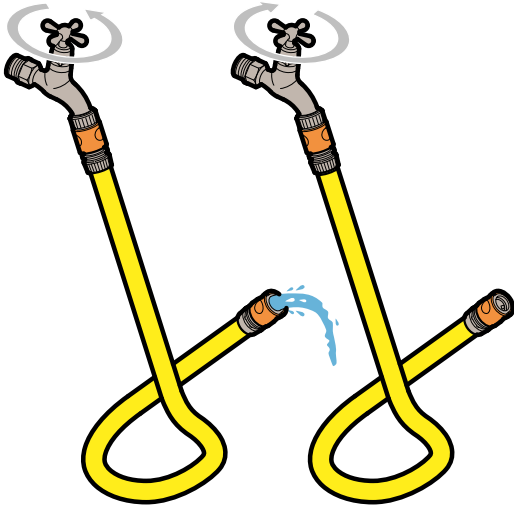

3



B



4

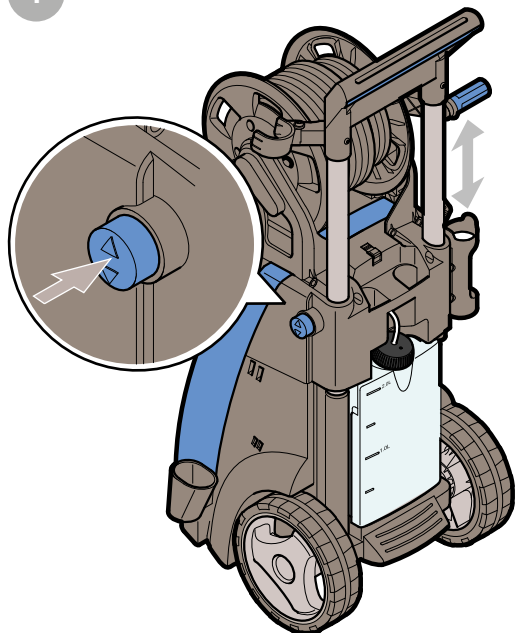

5

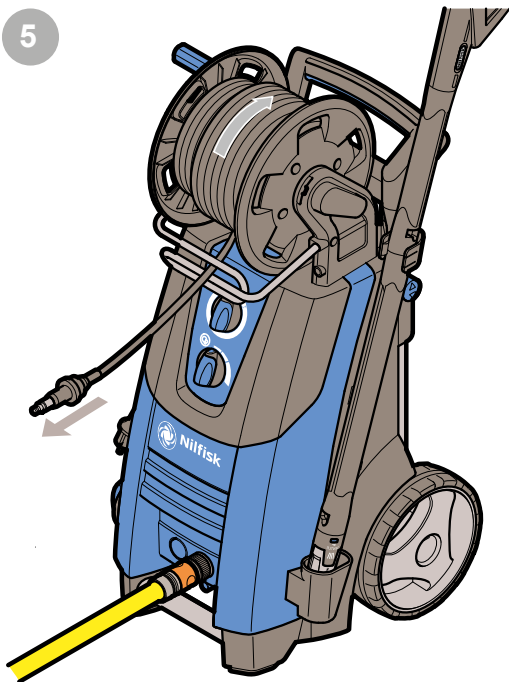

6

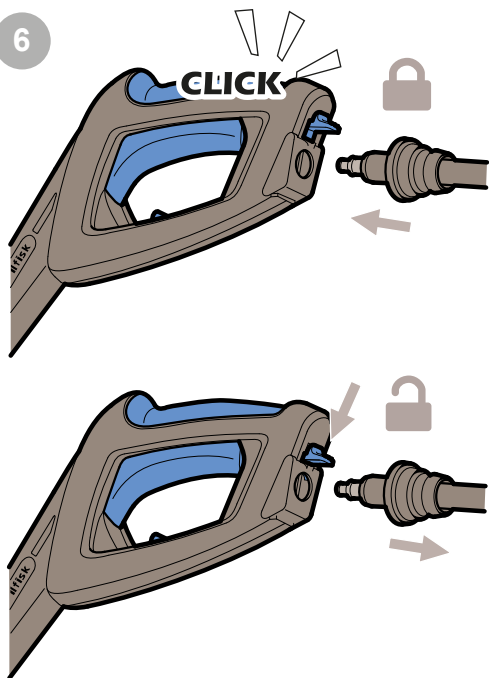

7

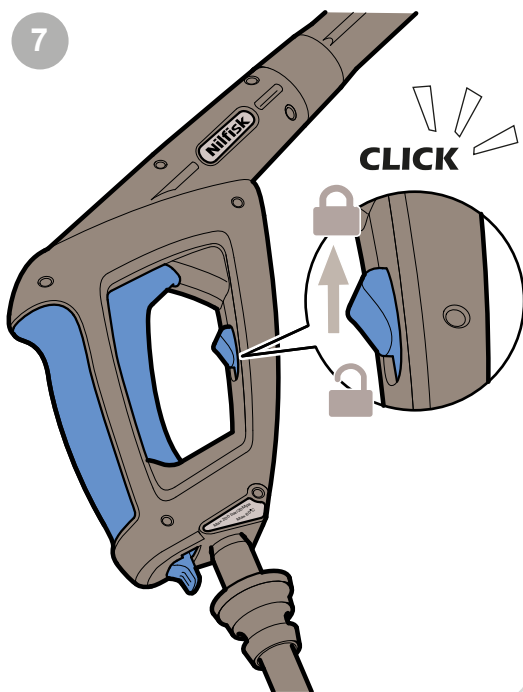

B



8

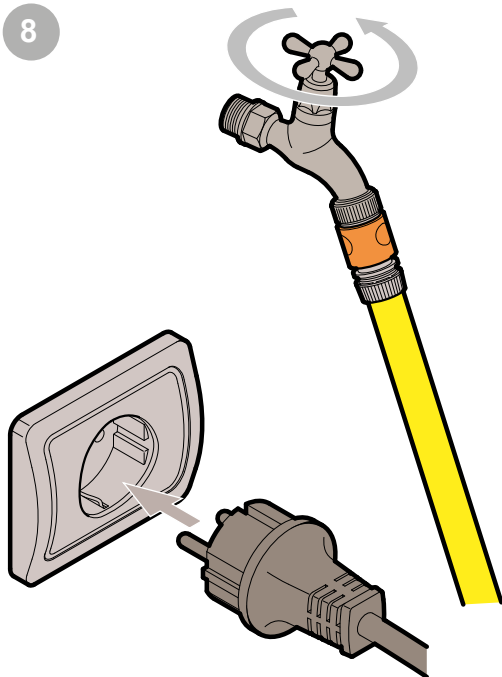

9

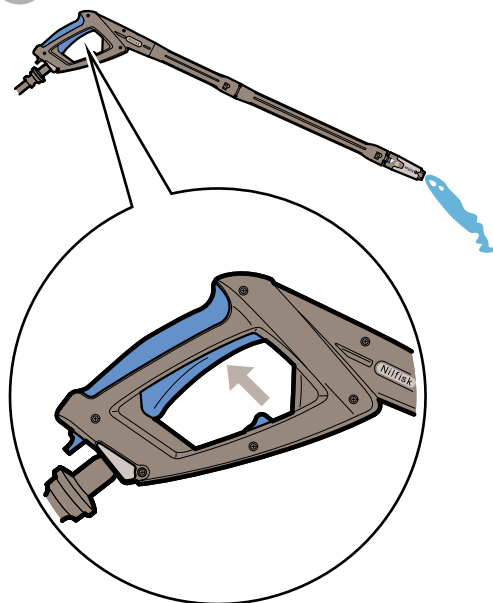

10

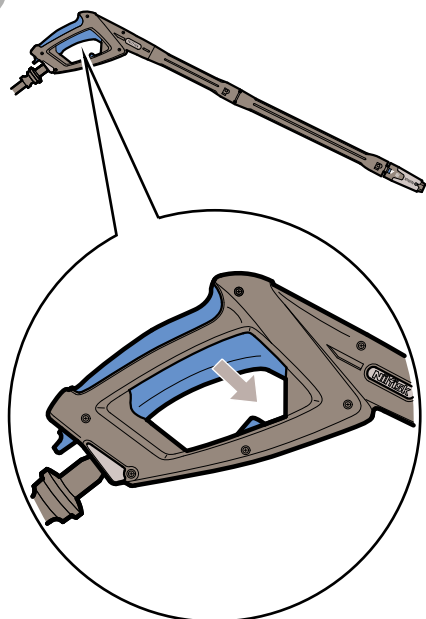

11

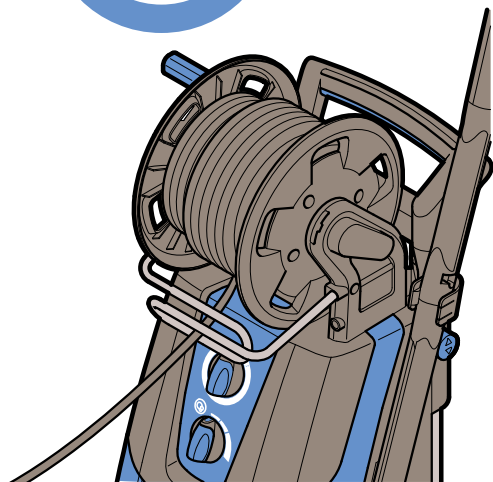
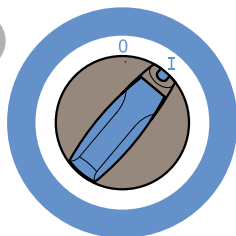

B



12

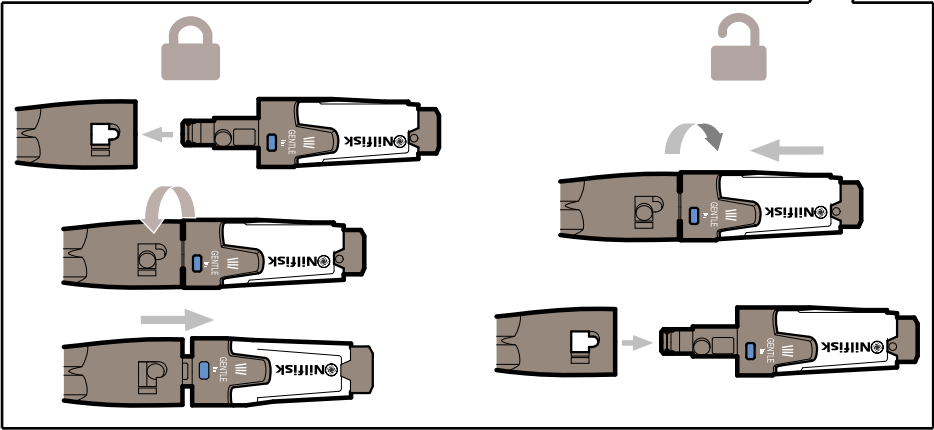
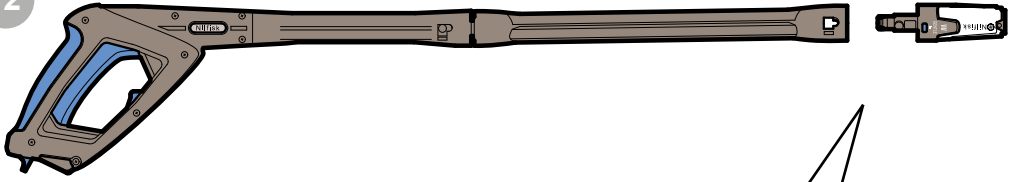

13



ROUGH NOZZLE

GENTLE NOZZLE



HARD SURFACES ONLY



14

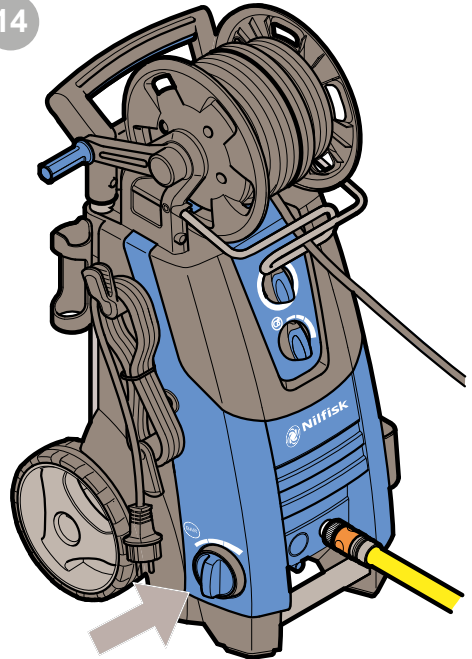

B



15

MAX

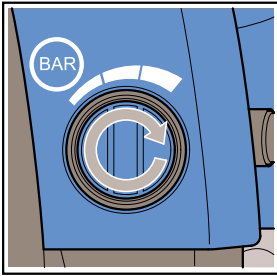

360° x 1,5

MIN

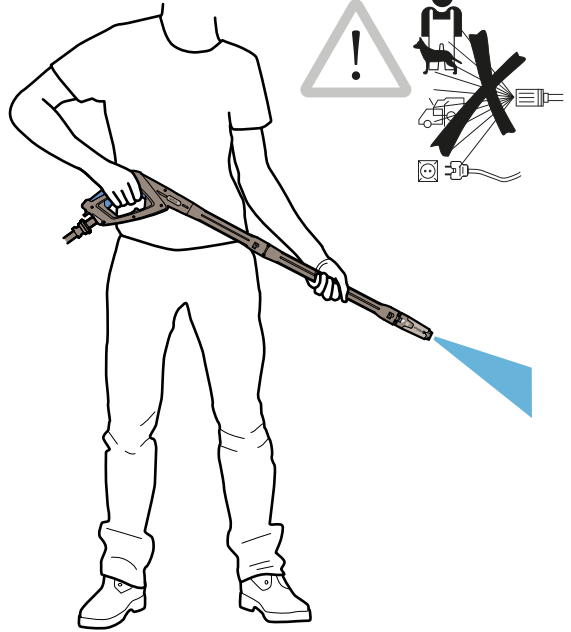
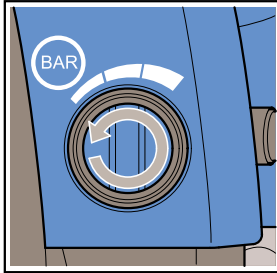

16

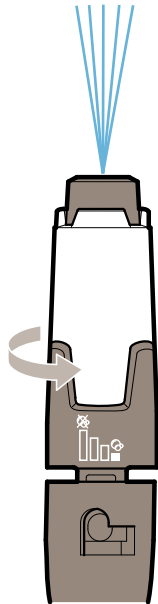

MIN

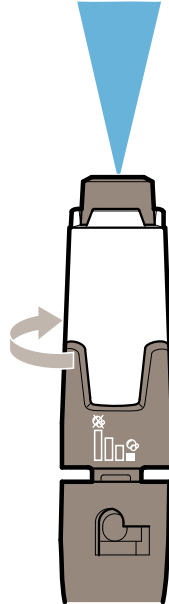

MAX

B



17

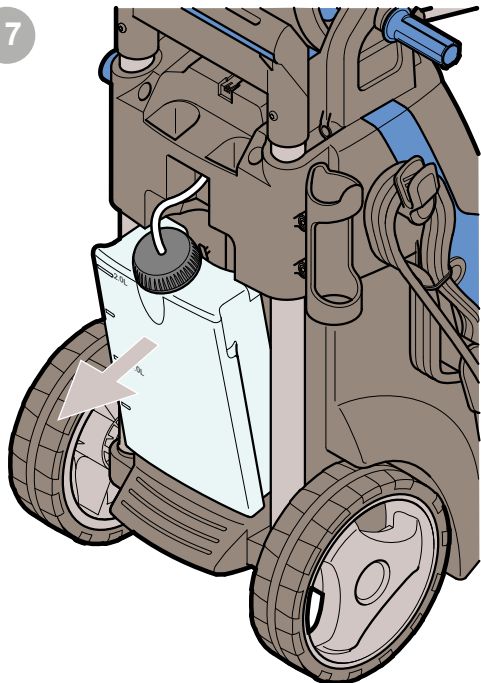

18

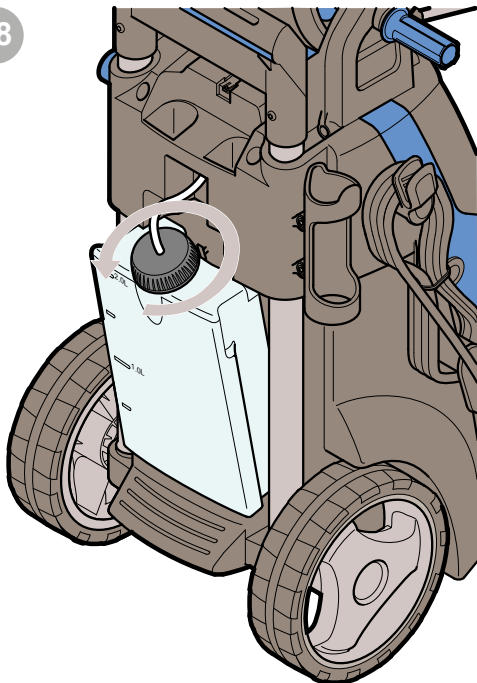

19

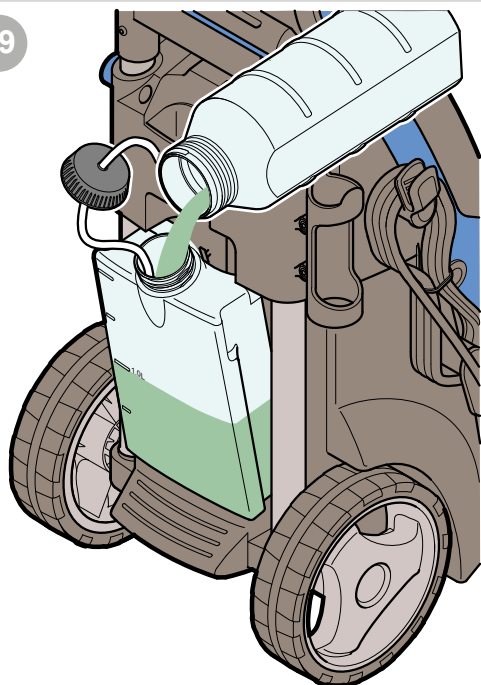

20

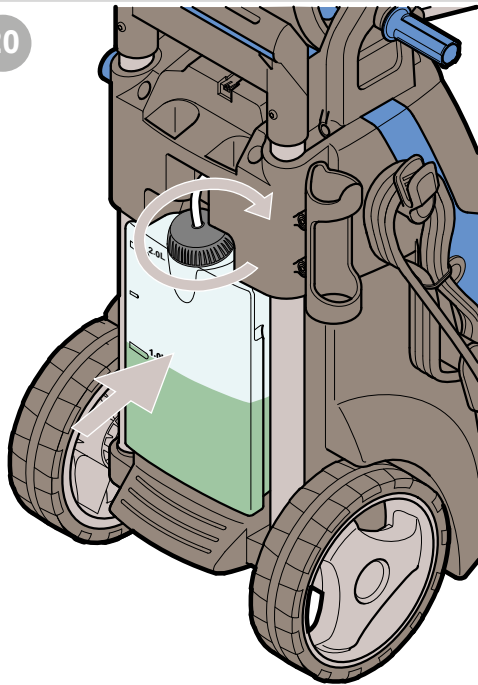

B



21

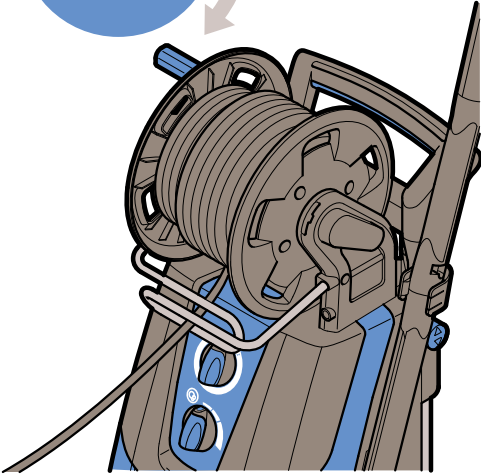
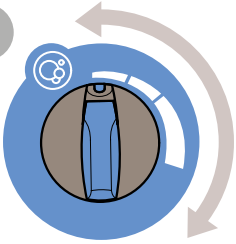

22



23

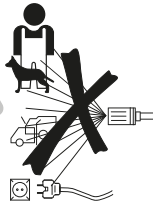
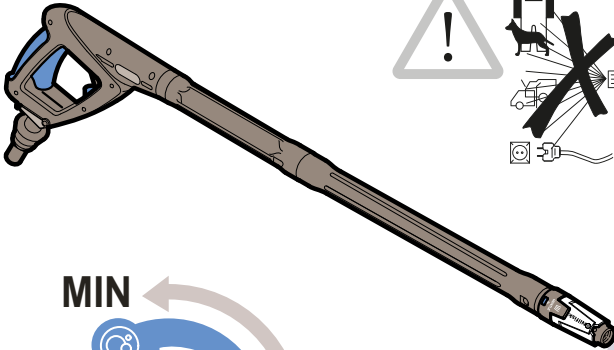

MIN

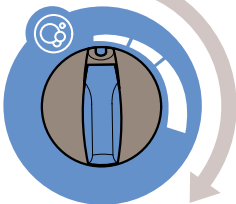

MAX

C

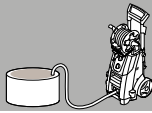

1

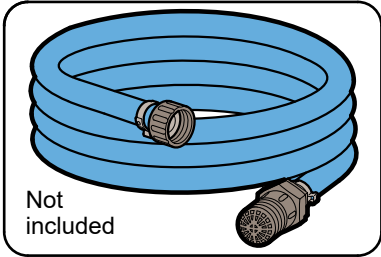

Not included

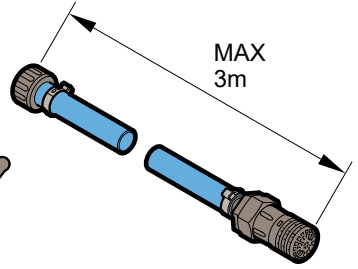

MAX
3m

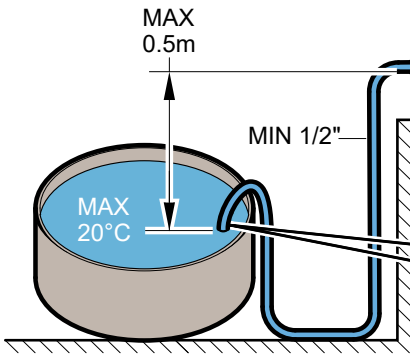

MAX
0.5m

MIN 1/2"

MAX
20°C

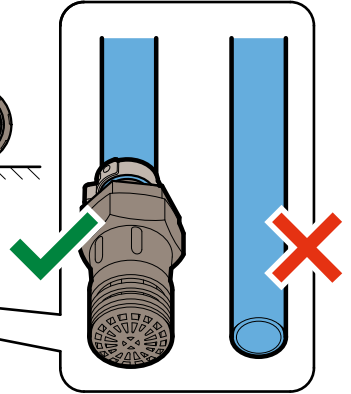

2

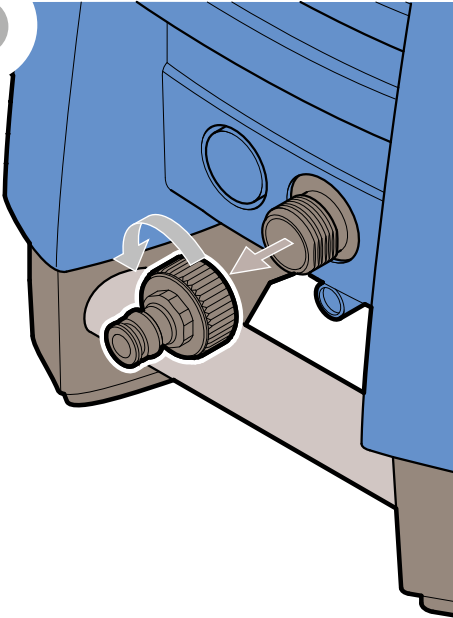

3

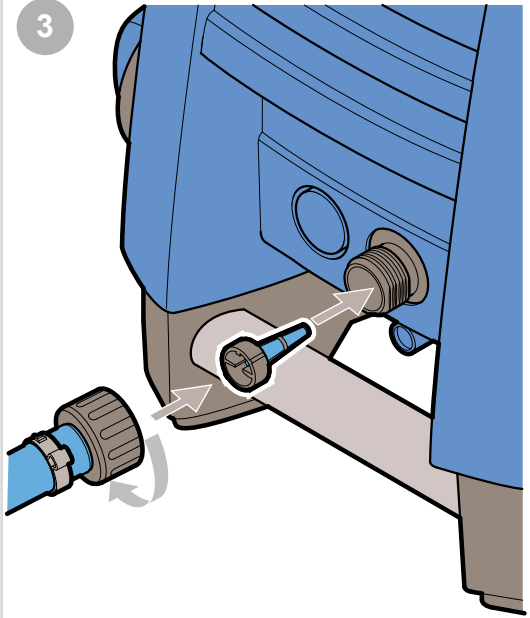

C

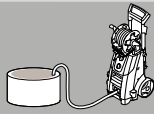

4

4.1

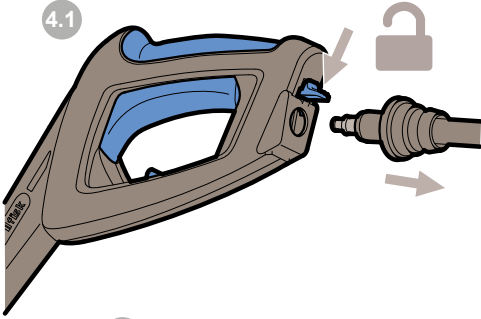

4.2

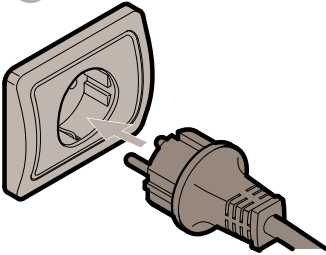

5

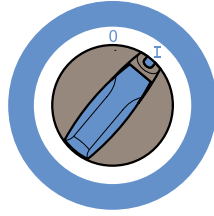

MAX 2min



6

6.1

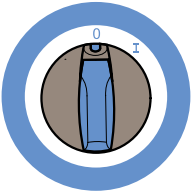

6.2

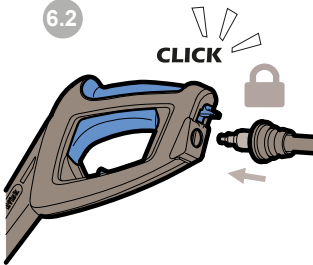

6.3

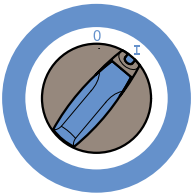

6.4

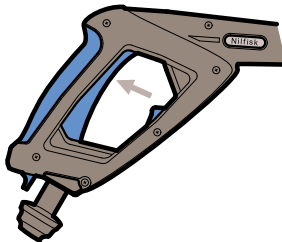

7



D

⏸ >5min



1

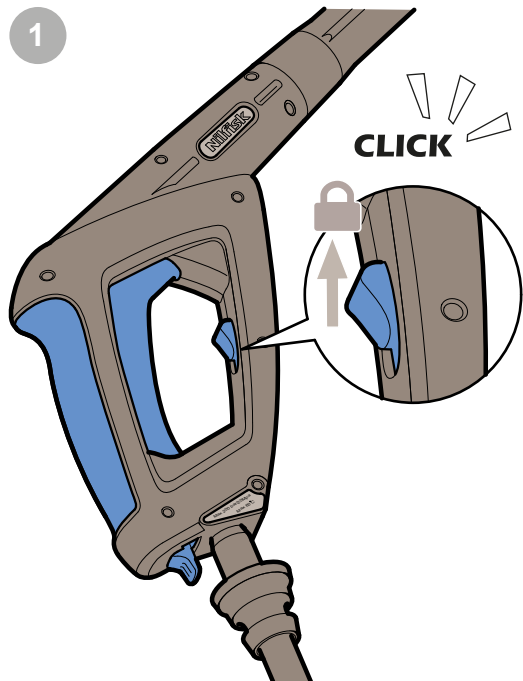

2

2.1

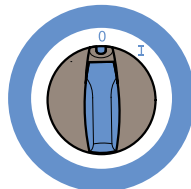

2.2

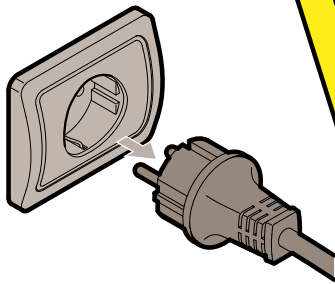

2.3

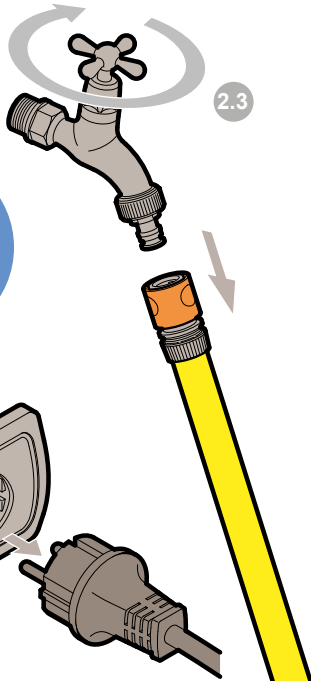

E

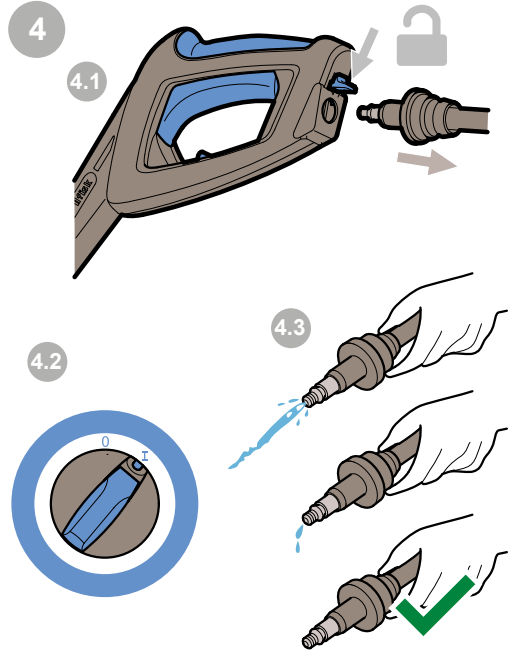
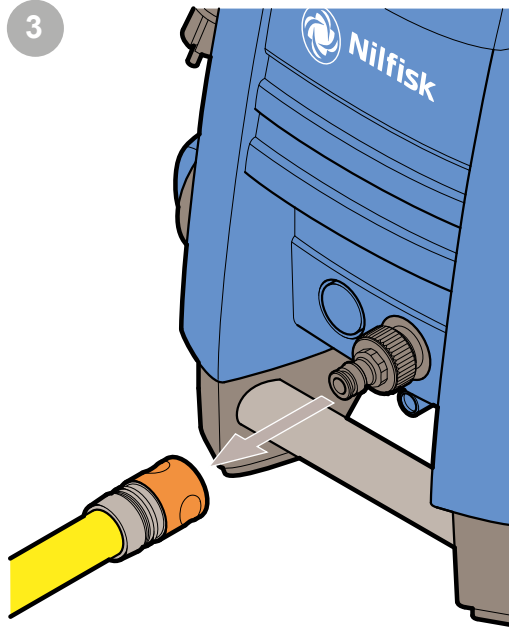
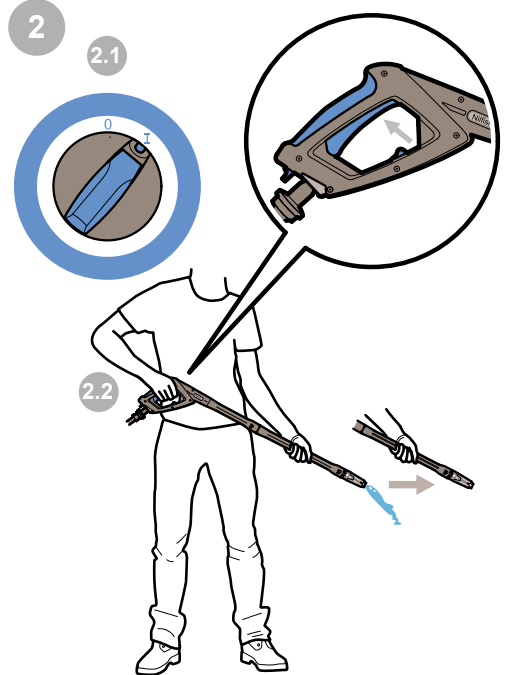
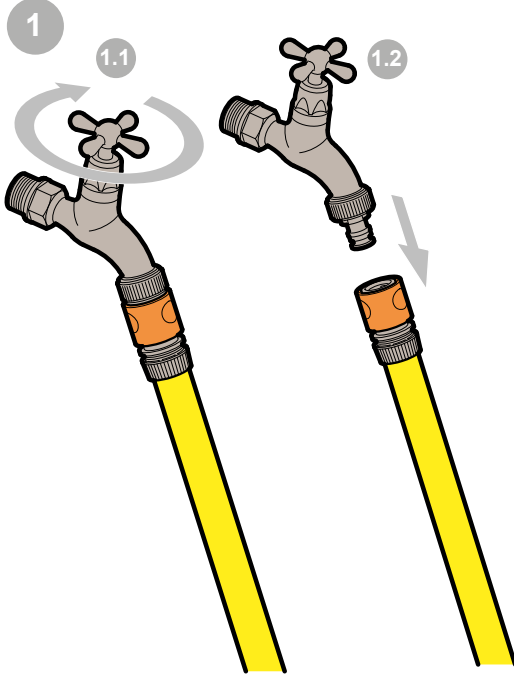

E



5

5.1

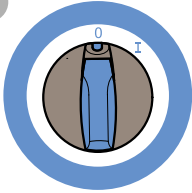

5.2

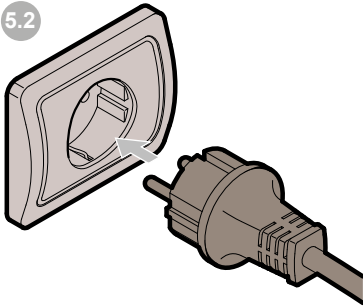

6

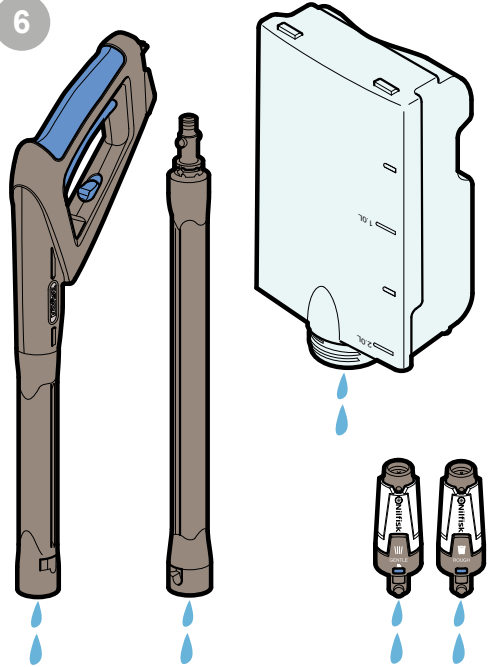

7

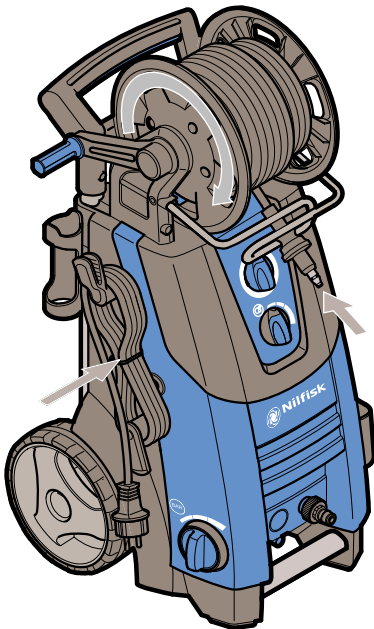

8

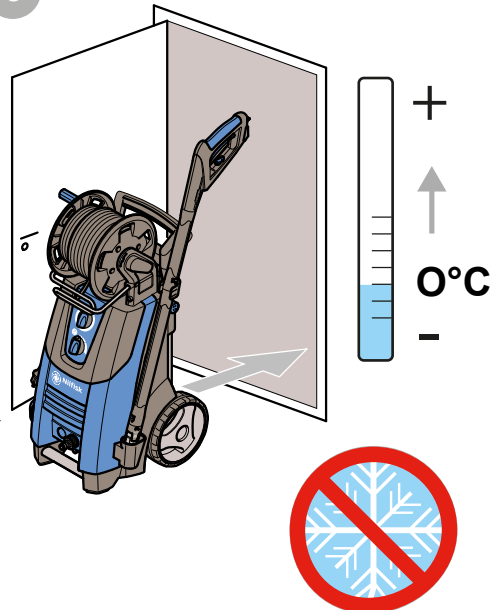

F



1

1.1

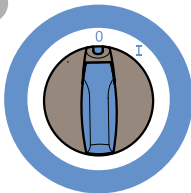

1.2

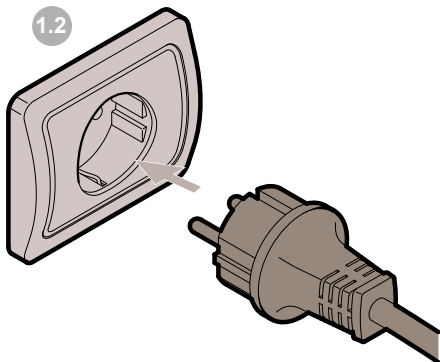

2

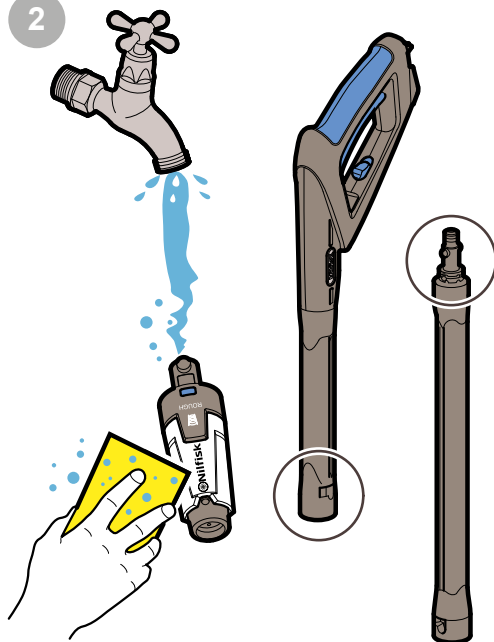

3

3.1

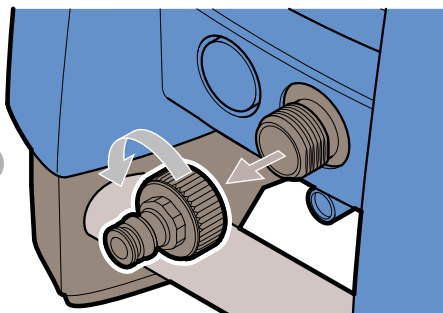

3.2

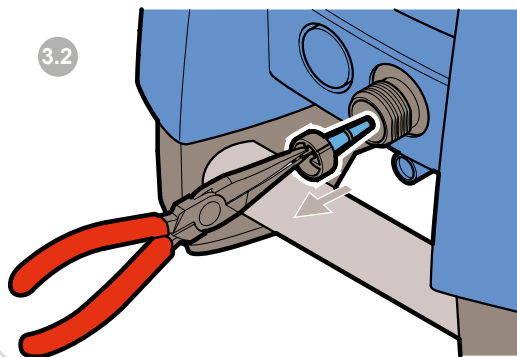

4

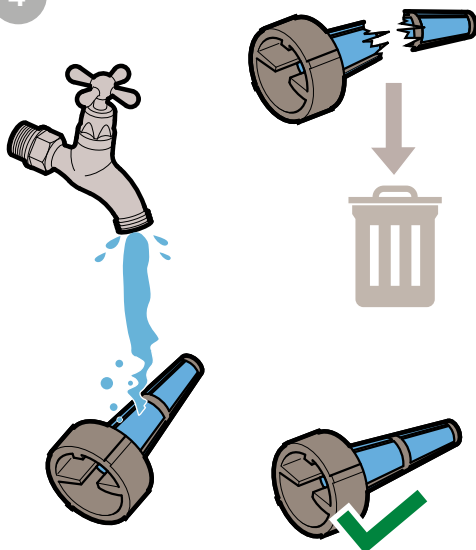

F



5

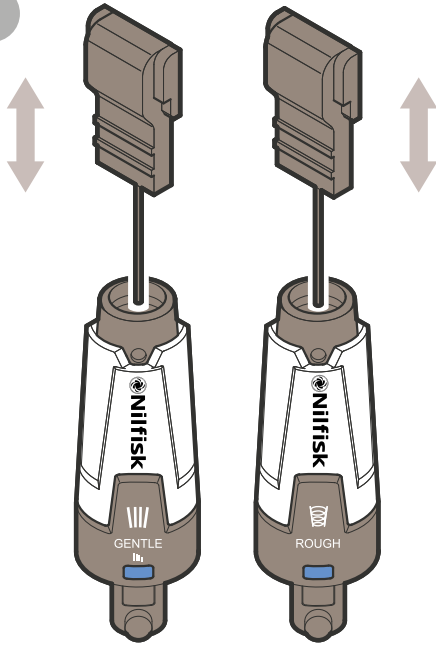

6

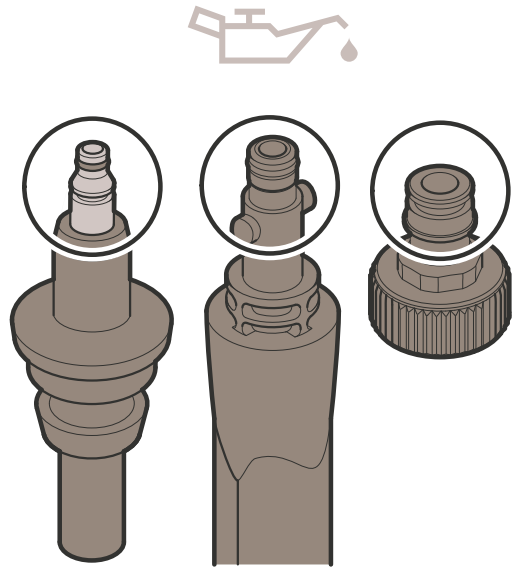

7

7.1

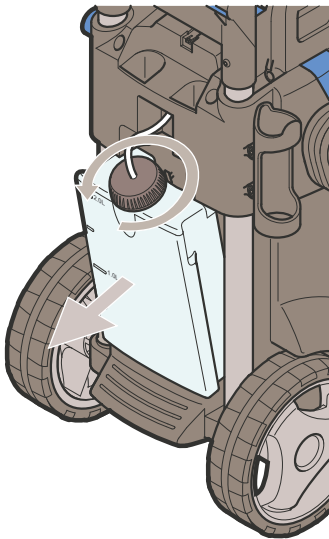

7.2

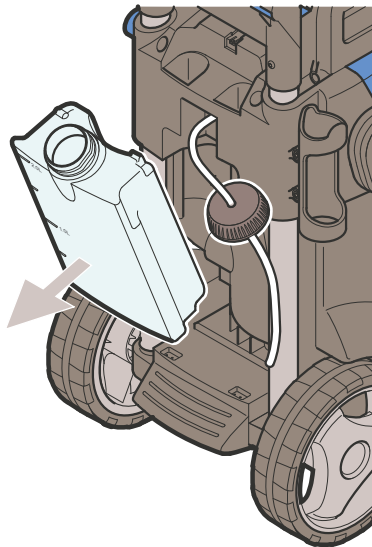

7.3

