

**LED MAX 48W 35V**  
**220-240V~ 50/60Hz**

Frequency Bandwidth	Maximal radiation transmitting power
2402 MHz	-7.5dBm

**GLOBO**  
 LIGHTING  
[www.globo-lighting.com](http://www.globo-lighting.com)

**48558-48**

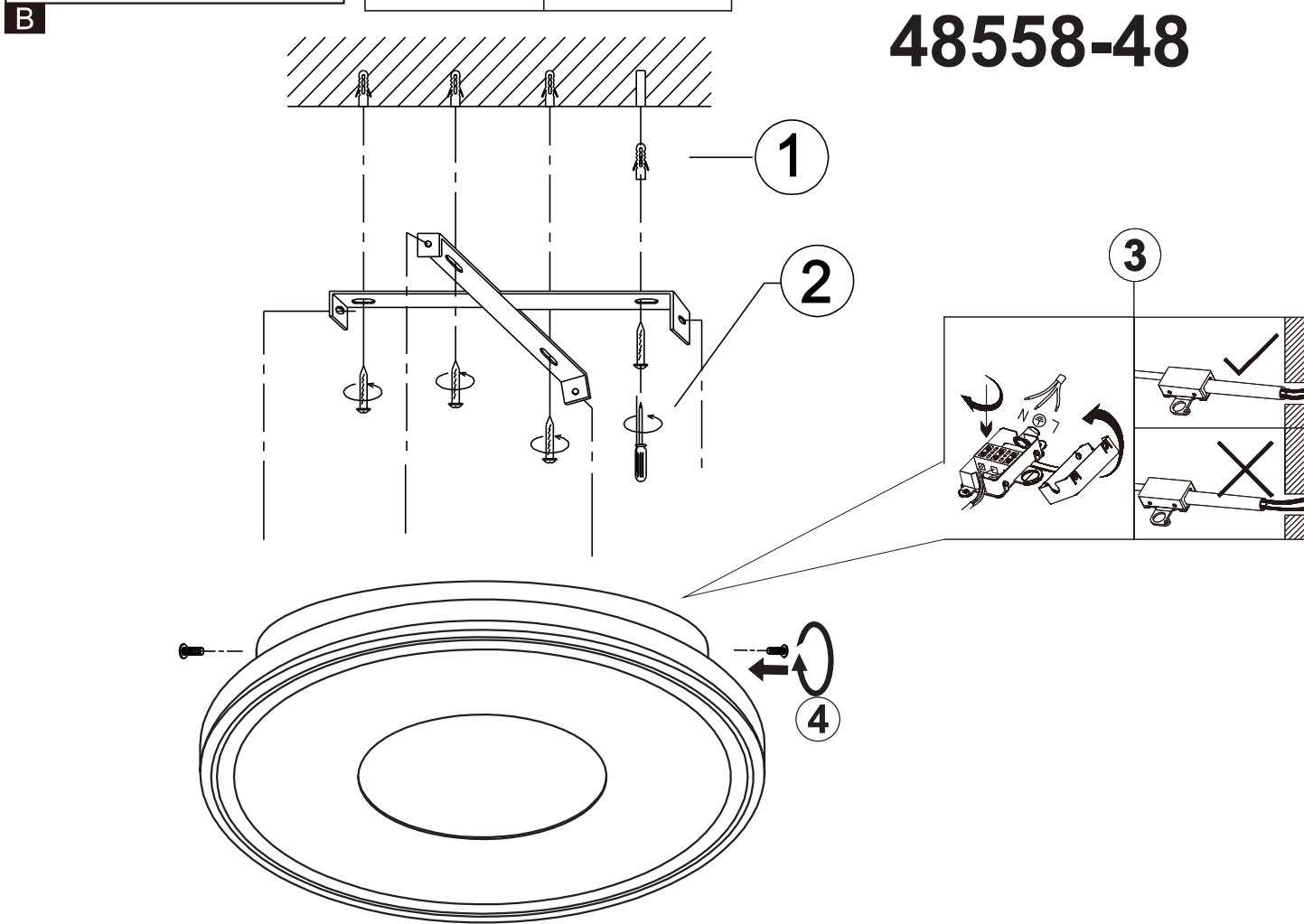

- incl. remote control
- 260-2640lm output
- dimmable
- 2700 K - 6000 K
- 3 LIGHT STEPS (2700 K, 4000 K, 6000 K)
- colour fixing
- many steps
- memory function
- night light
- timer

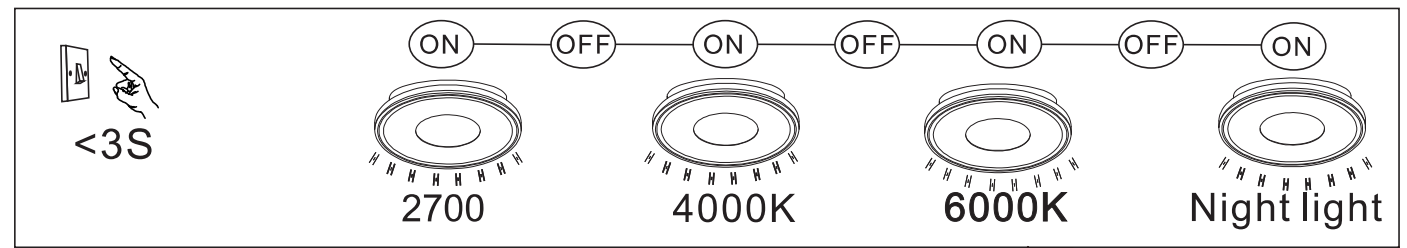
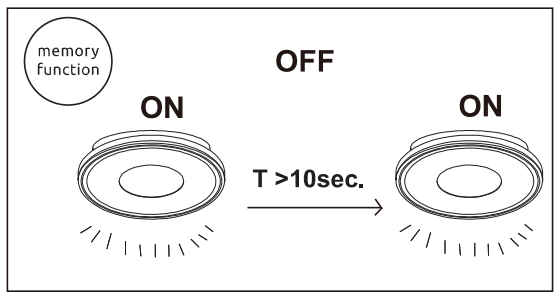
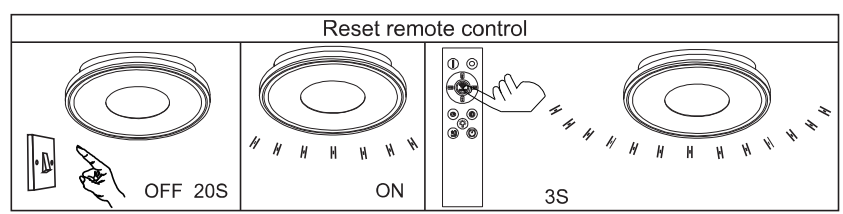

GLOBO Handels GmbH  
 Gewerbestr. 3  
 A-9184 Sankt Peter Austria  
[www.globo-lighting.com](http://www.globo-lighting.com)  
[office@globo-lighting.com](mailto:office@globo-lighting.com)

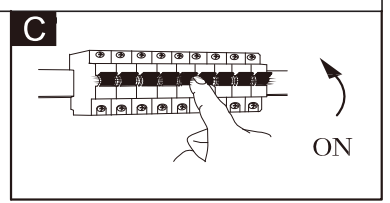

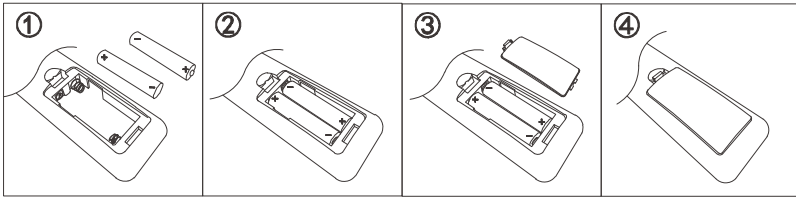

Battery: 2 x AAA 1.5V

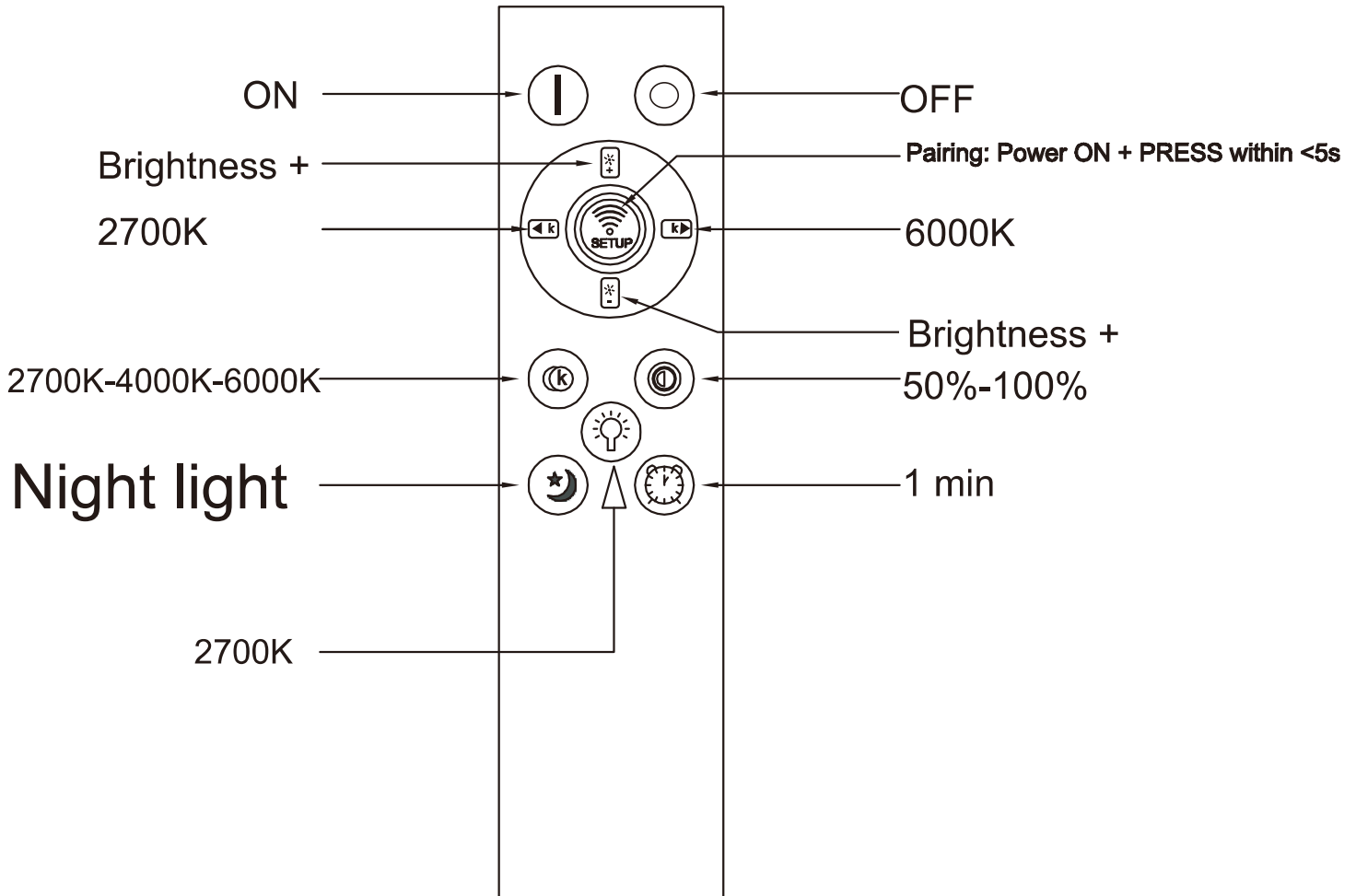

## BATTERY DATA

2xAAA Super Heavy Duty Battery\*incl.

\*Manufacturer: Shenzhen GMCELL TECHNOLOGY CO.,LTD

Address: G Building, Hualian Panorama International Building, 27 District,  
Bao'an, Shenzhen, China

Model: R03P UM-4 1.5V

## SAFETY INSTRUCTIONS



**Lichtquelle/Light source:**

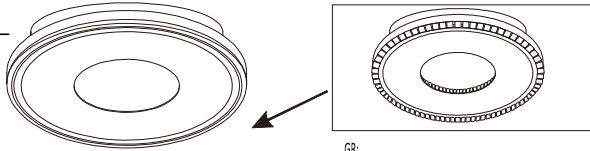

**DEU:**

**Lichtquelle:**  
Die Lichtquelle ist nicht tauschbar, weil sie konstruktionsbedingt fest mit dem umgebenden Produkt verbunden ist.

Dieses Produkt enthält eine Lichtquelle der Energieeffizienzklasse <E>.



Die LED - Lichtquelle ist nicht austauschbar.



Das Betriebsgerät kann nur durch einen Fachmann ausgetauscht werden.

**GBR:**

**Light source:**  
The light source is not interchangeable because it is determined by the surrounding product design. This product contains a light source of energy efficiency class <E>.



The LED - light source cannot be replaced.



The control gear can be replaced by a professional.

**BIH:**

**Izvor svjetla:**  
Izvor svjetla nije zamjenjiv, jer je konstrukcijski pričvršćen na proizvod.  
Ovaj proizvod sadržava izvor svjetlosti klase energetske učinkovitosti <E>.



LED – izvor svjetla nije moguće zamjeniti



Pogonski uređaj smije zamjeniti samo stručna osoba.

**BG:**

**Източник на светлина:**  
Източникът на светлина не може да се подменя, тъй като поради конструкцията си е трайно фиксиран към заобикалящия го продукт.  
Този продукт включва светлинен източник с клас на енергийна ефективност <E>.



LED източникът на светлина не може да се подменя.



Устройството за управление може да се подменя само от специалист.

**CZ:**

**Zdroj světla:**  
Světelný zdroj není možné vyměnit, protože je díky své konstrukci pevně spojený s produktem.  
Tento výrobek obsahuje světelný zdroj s třídou energetické účinnosti <E>.



Světelný zdroj není vyměnitelný.



Výměna předradníku pouze odborníkem

**DK:**

**Lyskilde:**  
Lyskilden kan ikke udskiftes, fordi den er fast forbundet med det omgivende produkt.  
Dette produkt indeholder en lyskilde i energieffektivitetsklasse <E>.



LED- lyskilden kan ikke udskiftes.



Driftsenheden kan kun skiftes af en fagperson.

**ET:**

**Valgusallikas:**  
Valgusallikas ei ole välja vahetatav, sest ta on tootege ehituslikult kindlalt seotud.  
Toode sisaldab energiatõhususe klassi <E> valgusallikat.



LED - valgusallikat ei saa asendada.



Juhtseadmed võib asendada professionaalne.

**FI:**

**Valonlähde:**  
Valonlähdeä ei voi vaihtaa uuteen, sillä se on rakenteellisesti yhdistetty ympäröivään tuoteeseen.  
Tämä tuote sisältää valonlähteen, jonka energiatehokkuusluokka on <E>.



LED-valonlähdeä ei voi vaihtaa uuteen.



Vain ammattihenkilö voi vaihtaa liitäntälaitteen.

**FR:**

**Source lumineuse:**  
La source lumineuse n'est pas remplaçable car elle est, de par la construction du produit, liée de façon permanente à celui-ci.  
Ce produit contient une source lumineuse de classe d'efficacité énergétique <E>.



La source lumineuse LED n'est pas remplaçable.



L'unité de contrôle ne peut être remplacée que par un spécialiste.

**GR:**

**Φωτεινή πηγή:**  
Η φωτεινή πηγή δεν μπορεί να αντικατασταθεί, επειδή είναι για κατασκευαστικούς λόγους στερεά συνδεδεμένη με το προϊόν που την περιβάλλει.  
Το προϊόν αυτό περιέχει φωτεινή πηγή της τάξης ενεργειακής απόδοσης <E>.



Η φωτεινή πηγή LED δεν αντικαθίσταται.



Η λειτουργική συσκευή μπορεί να αντικατασταθεί μόνο από ΕΝΩΝ ΕΙΔΙΚΟ.

**HU:**

**Fényforrás:**  
A fényforrás nem cserélhető, mert felépítése miatt szilárdan csatlakozik a termékhez. Ez a termék egy <E> energiateljesítményű osztályú fényforrást tartalmaz.



A fényforrás nem cserélhető



Az előlétet csak szakértők cserélhetik ki.

**Islandisch/IS:**

**Ljósgráfi:**  
Ljósgráfiinn er ekki útskiptanlegur vegna þess að hann er háður umliggjandi hönnun vörunnar.  
Varan inniheldur ljósgráfi a orkuflökki <E>.



EKKI er hægt að skipta um LED-ljósgráfiann.



Aðeins fagmenn mega skipta um stjórnbúnaðinn.

**IT:**

**Sorgente luminosa:**  
La sorgente luminosa non è intercambiabile perché è saldamente collegata al prodotto per via del suo design.  
Questo prodotto contiene una sorgente luminosa di classe di efficienza energetica <E>.



La sorgente luminosa a LED non può essere sostituita.



L'alimentatore può essere sostituito solo da personale specializzato.

**HR:**

**Izvor svjetla:**  
Izvor svjetla nije zamjenjiv, jer je konstrukcijski pričvršćen na proizvod.  
Ovaj proizvod sadržava izvor svjetlosti klase energetske učinkovitosti <E>.



LED – izvor svjetla nije moguće zamjeniti



Pogonski uređaj smije zamjeniti samo stručna osoba.

**LV:**

**Gaismas avots:**  
Gaismas avotu nevar nomainīt, jo tas konstrukcijā ir cieši savienots ar izstrādājuma apkārtējo daļu.  
Šis ražojums satur gaismas avotu, kura energoefektivitātes klase ir <E>.



LED apgaismes līdzekļi nevar nomainīt.



Vadības ierīci var nomainīt speciālists.

**LT:**

**Šviesos šaltinis:**  
Šis šviesos šaltinis yra nekeičiamas, nes jis prijungtas prie gaminio pagal jo konstrukciją.  
Šiame gaminyje yra šviesos šaltinis, kurio energijos vartojimo efektyvumo klasė <E>.



LED šviesos šaltinis yra nekeičiamas.



Valdymo įtaisų gali pakeisti tik tam kvalifikuotas specialistas.

**NL:**

**Lichtbron:**  
De lichtbron kan niet worden vervangen, omdat deze vanwege de constructie vast met het product eromheen verbonden is.  
Dit product bevat een lichtbron van energie-efficiëntieklasse <E>.



De LED-lichtbron kan niet worden vervangen.



Het apparaat kan alleen door een vakman worden vervangen.

**Norwegisch/Norwegian / NO:**

**Lyskilde:**  
Lyskilden kan ikke byttes fordi den sitter fast i produktet.  
Dette produktet inneholder en lyskilde i energiklasse <E>.



LED-lyspæren kan ikke byttes.



Driverehelen kan kun byttes av fagmann.

**PL:**

**Źródło światła:**  
Źródła światła nie można wymienić, ponieważ jest zintegrowane z produktem ze względu na swoją konstrukcję.  
Ten produkt zawiera źródło światła o klasie efektywności energetycznej <E>.



LED - źródło światła nie może być wymienione.



Urządzenie sterujące może zostać wymienione przez specjalistę.

**PT:**

**Fonte de Luz:**  
A fonte de luz não é substituível porque devido às suas características construída com a estrutura permanente ao produto circundante.  
Este produto contém uma fonte de luz da classe de eficiência energética <E>.



Lâmpada não substituível.



Substituição do equipamento de controlo por um profissional.

**RO:**

**Sursa de lumina:**  
Sursa de lumina nu este inlocuibilă ea fiind parte constructivă a produsului.  
Acest produs conține o sursă de lumină cu clasa de eficiență energetică <E>.



Sursa de lumina nu poate fi înlocuită



Driverul poate fi înlocuit doar de către personal specializat

**RUS:**

**Источник света:**  
Источник света не является взаимозаменяемым, поскольку это определяется конструкцией смежного продукта.  
Данный продукт содержит источник света класса энергоэффективности <E>.



Светодиодный источник света не подлежит замене.



Устройство управления может заменяться только квалифицированным специалистом.

**SRB:**

**Izvor svetlosti:**  
Izvor svetlosti nije zamjenjiv, jer je zbog svog dizajna čvrsto povezan sa proizvodom koji ga okružuje.  
Ovaj proizvod sadrži izvor svetlosti klase energetske efikasnosti <E>.



LED izvor svetlosti nije zamjenjiv.



Upravljački uređaj može da zameni samo specijalista.

**SK:**

**Zdroj svetla:**  
Svetelný zdroj nie je možné vymeniť, pretože je vďaka svojej konštrukcii pevne spojený s produktom.  
Tento výrobok obsahuje svetelný zdroj triedy energetickej účinnosti <E>.



Svetelný zdroj nie je vymeniteľný.



Výmena predradníka len odborníkom.

**SI:**

**Izvor svetlobe:**  
Vir svetlobe ni zamenljiv, ker je določen z zasnovano izdelka v okolici.  
Ta izdelek vsebuje svetlobni vir razreda energetske učinkovitosti <E>.



Svetlobni vir ni mogoče zamenjati.



Krmilno napravo lahko zamenja samo strokovno usposobljena oseba

**SE:**

**Ljuskälla:**  
Ljuskällan är inte utbyttbar, eftersom den på grund av konstruktionen är fast integrerad i den omgivande produkten.  
Denna produkt innehåller en ljuskälla med energieffektivitetsklass <E>.



LED-ljuskällan kan inte bytas ut.



Driftdonet kan endast bytas ut av en fackman.

**TR:**

**Isik kaynağı:**  
Konstrüksiyon gereği çevreleyen ürün ile sabit bir şekilde bağlı olduğu için isik kaynağı değiştirilemez.  
Bu ürün, <E> enerji sınıfından bir isik kaynağına sahiptir.



LED isik kaynağı değiştirilemez.



İşletme cihazı sadece bir uzman tarafından değiştirilebilir.

**UK:**

**Джерело світла:**  
Джерело світла не можна обмінити, оскільки воно міцно пов'язане з навколишнім виробом завдяки своїй конструкції.

Цей виріб містить джерело світла класу енергоефективності <E>.



— джерело світлодіодного світла не можна замінювати.



— лише фахівць може замінювати пристрій керування.