

PLUS

PLUS A/S
 Ådalen 13B
 DK-6600 Vejen
 phone: +45 7996 3333
 web: www.plus.dk

17524-1

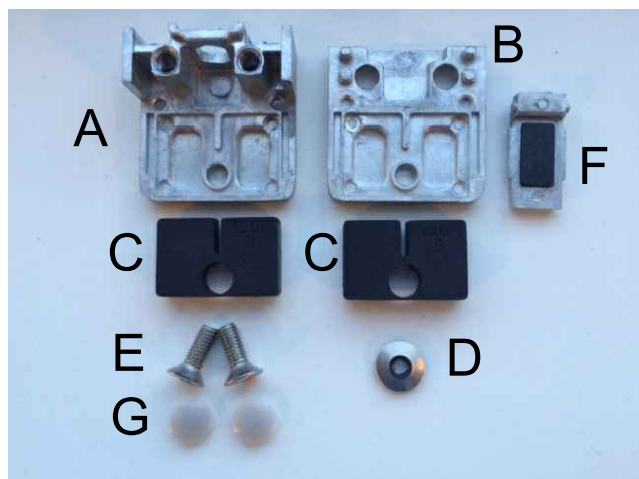

17524-15

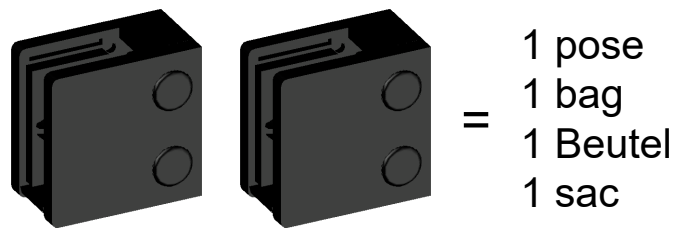
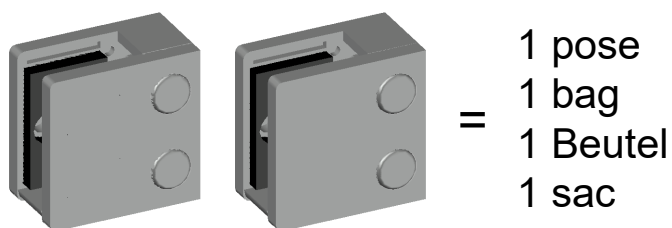
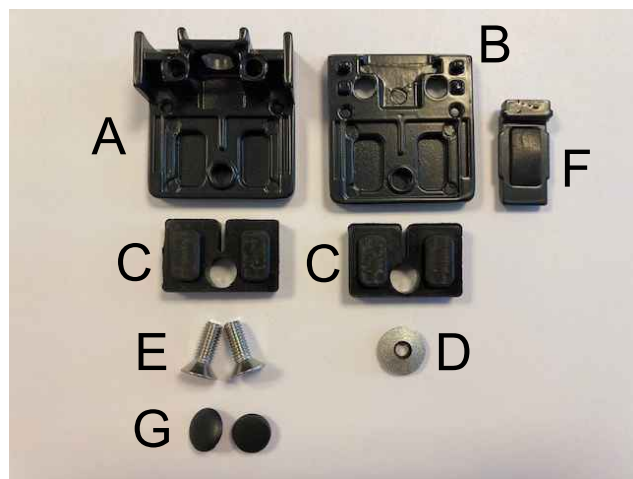

175240-1

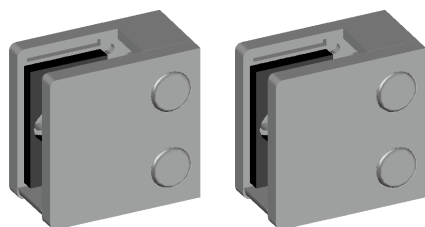

+

1752403

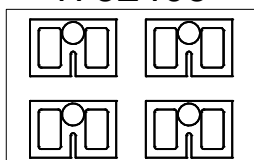

Til 8 mm glas / For 8 mm glass
 Für 8 mm Glas / Pour verre 8 mm

175240-15

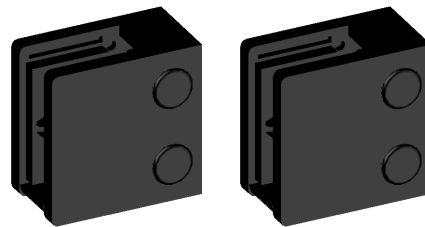

+

1752403

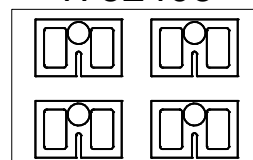

Til 8 mm glas / For 8 mm glass
 Für 8 mm Glas / Pour verre 8 mm

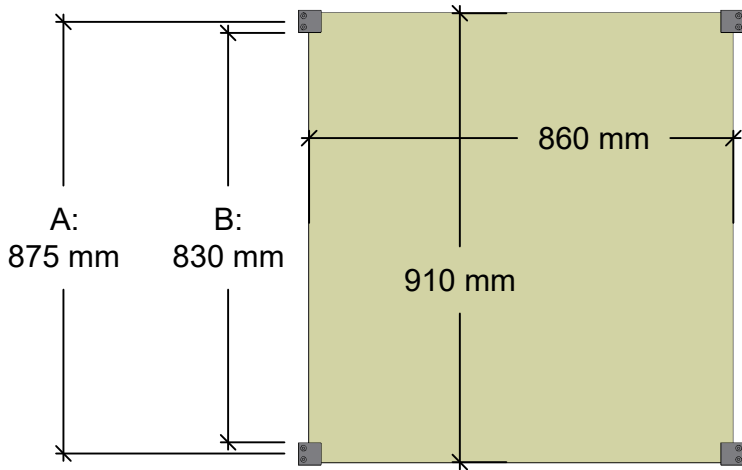

175393-1 + 175493-1

175395-1 + 175495-1

175396-1 + 175496-1 (8,76 mm)

175397-1 + 175497-1 (8,76 mm)

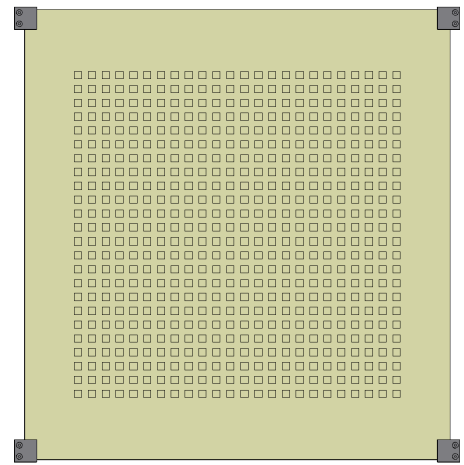

175394-1

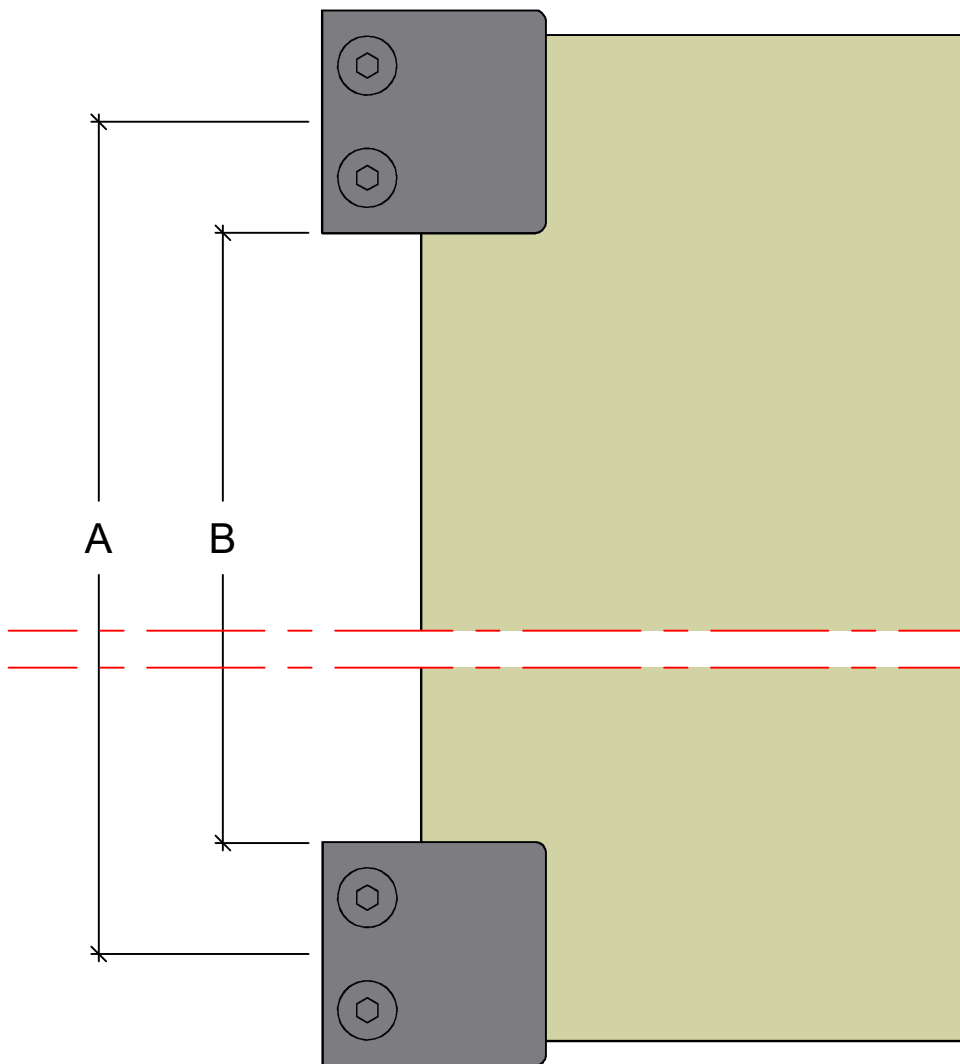

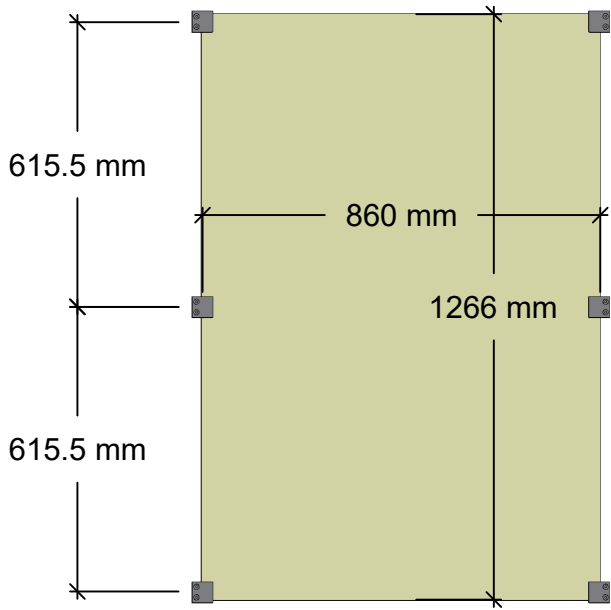

175363-1 + 175463-1

175365-1 + 175464-1

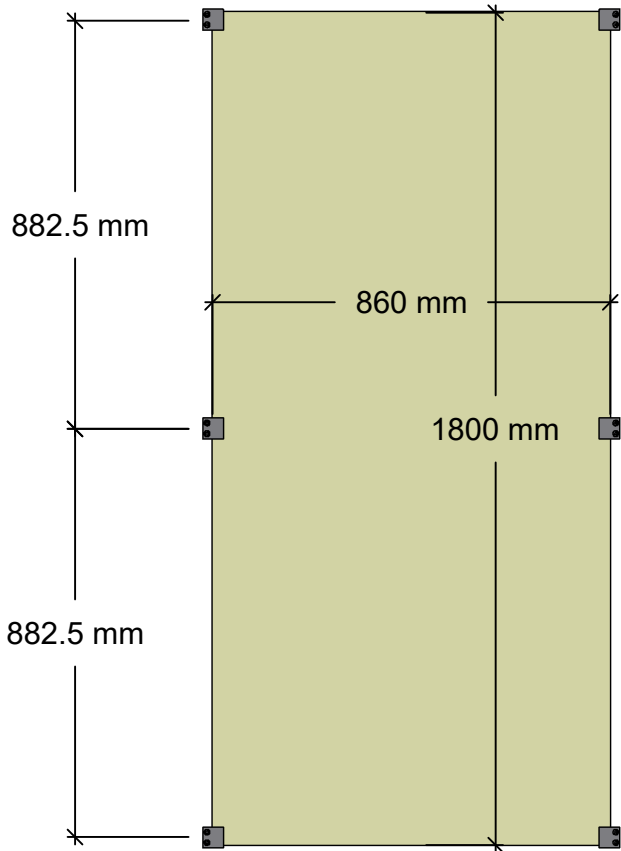

175353-1 + 175453-1

175355-1 + 175455-1

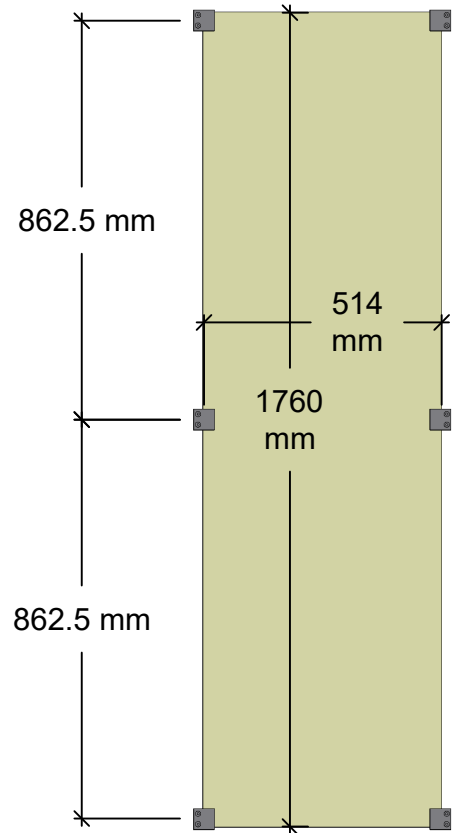

*175342-1

*175442-1

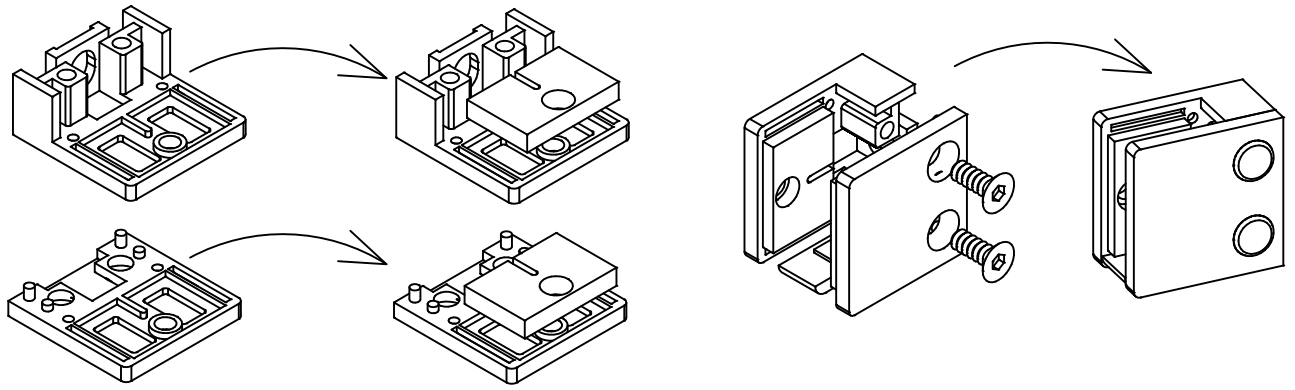

Se side 6 + 7 + 8
 Siehe Seite 6 + 7 + 8
 See page 6 + 7 + 8
 Voir page 6 + 7 + 8

1-2 mm tolerance
 1-2 mm tolerance
 1-2 mm Toleranz
 1-2 mm tolérance

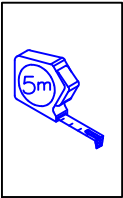

Afstand mellem stolperne
 Distance between the posts
 Abstand zwischen den Pfosten
 La distance entre les poteaux

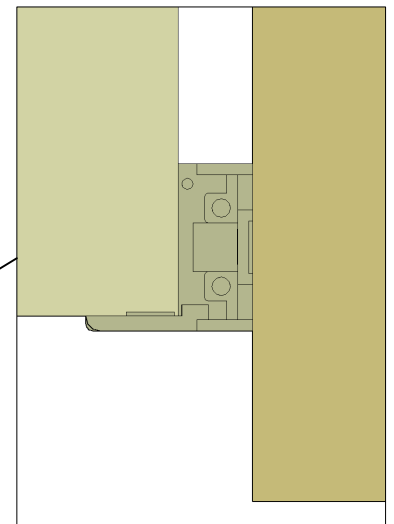
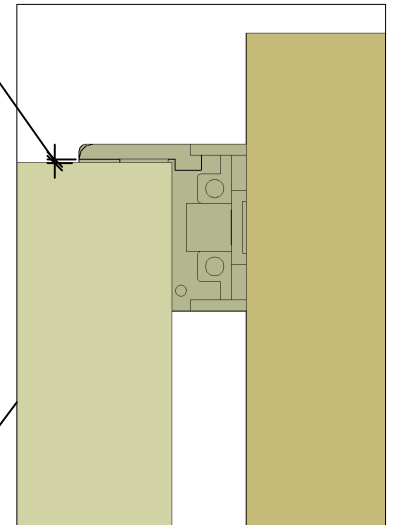
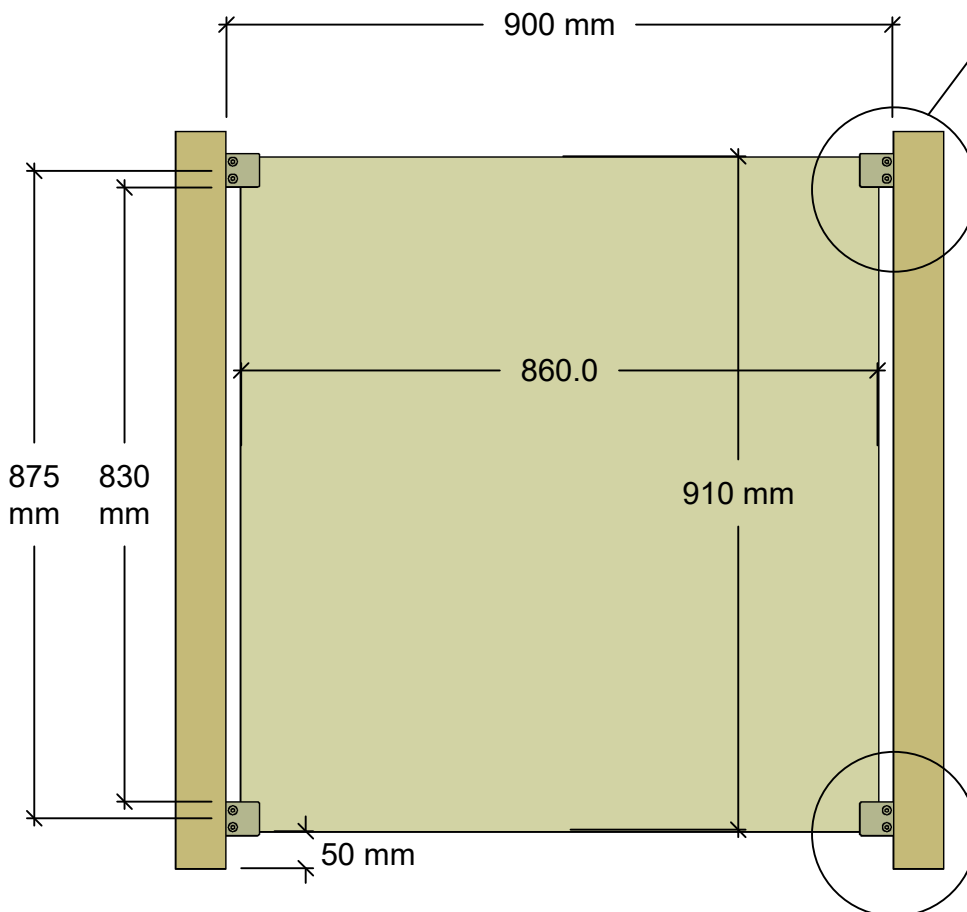



Se side 6 + 7 + 8
Siehe Seite 6 + 7 + 8
See page 6 + 7 + 8
Voir page 6 + 7 + 8

1-2 mm tolerance
1-2 mm tolerance
1-2 mm Toleranz
1-2 mm tolérance

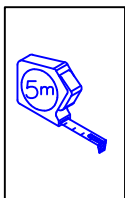

Afstand mellem stolperne
Distance between the posts
Abstand zwischen den Pfosten
La distance entre les poteaux

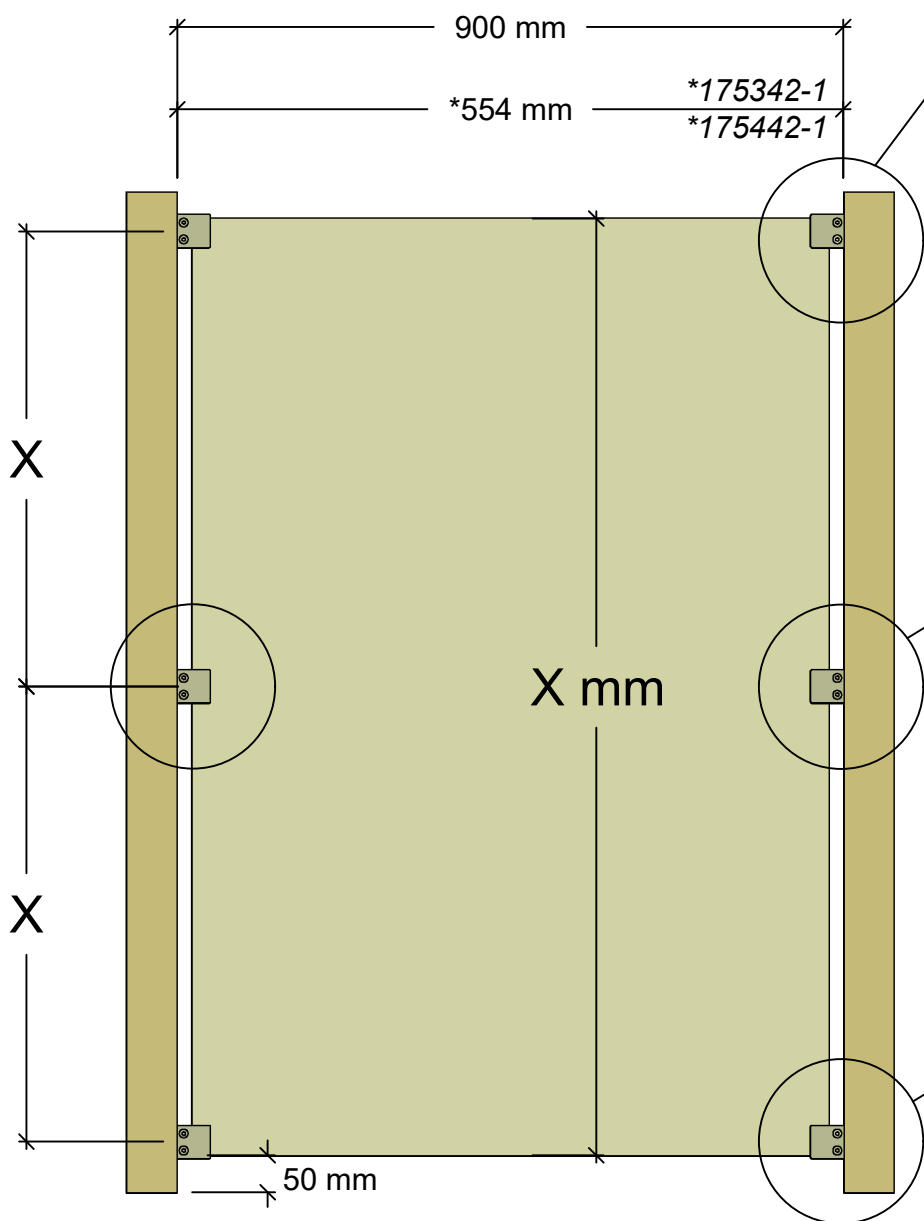
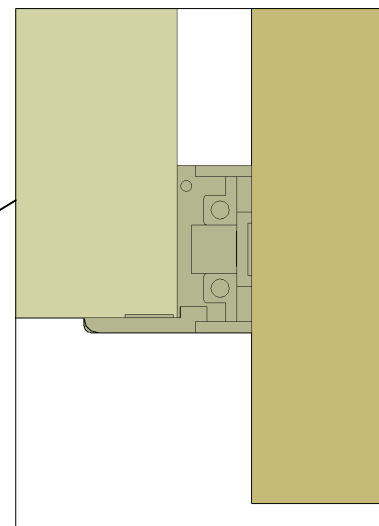
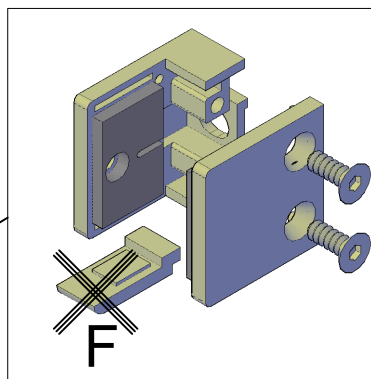
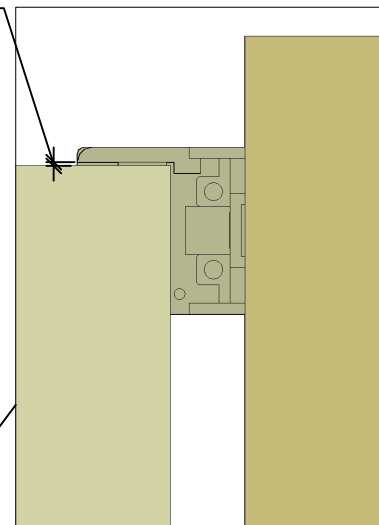

Træ stolper - Holz Pfosten - Wood post - Poteaux en bois

1.

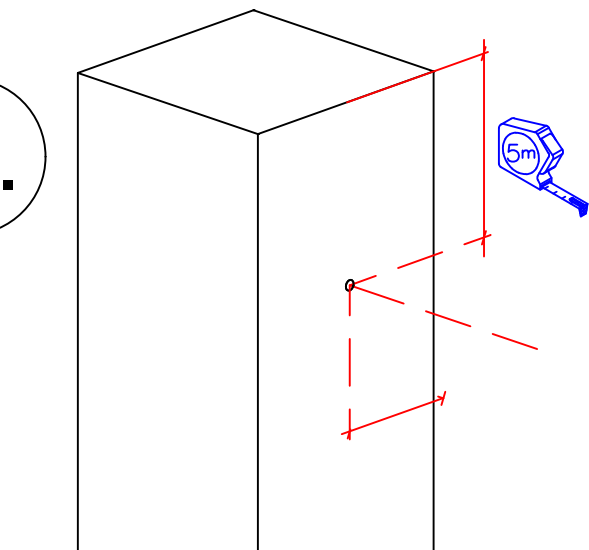
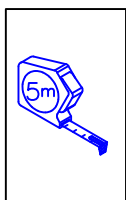

Afmærk på stolpen
Mark the post
Am Pfosten markieren
Marquer sur un poteaux

2.

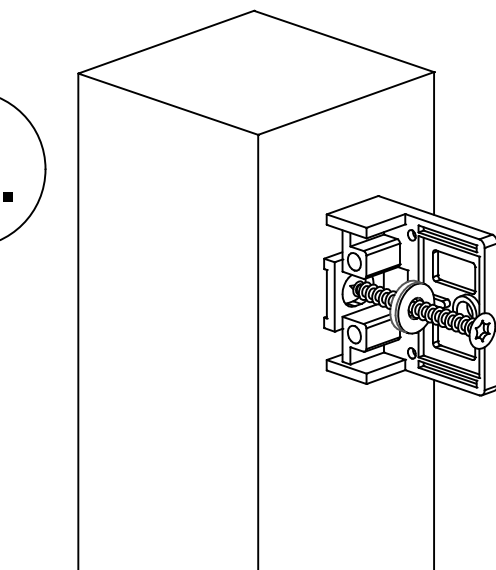
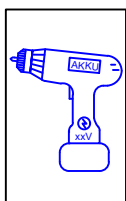

Beslaget monteres
Bracket mounted
Halterung montiert
Monté sur étrier

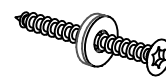
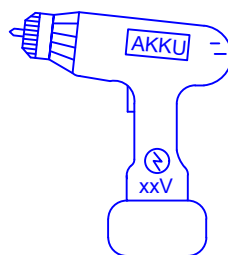

D

1.

2.

3.

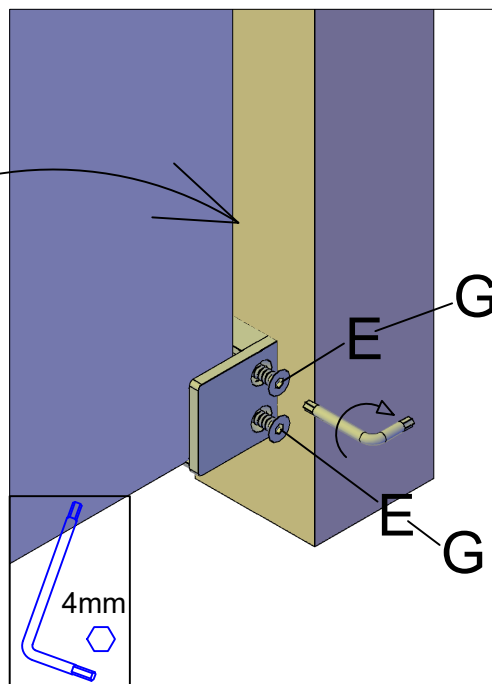
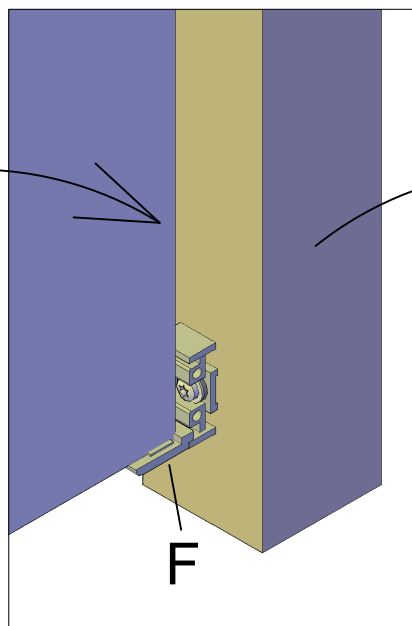
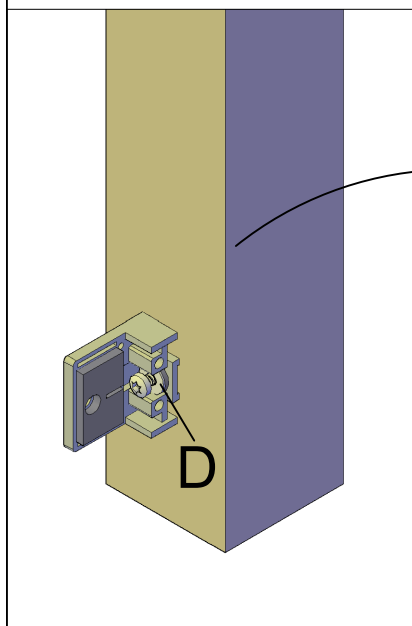

Stålstolper - Stahlpfosten - Steel posts - Poteaux acier

4,5 x 4,5
cm



8 x 8
cm

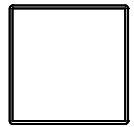

1.

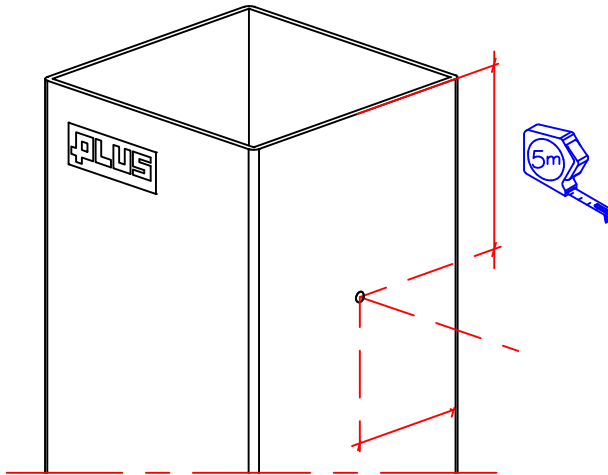
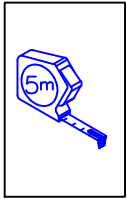

Afmærk på stolpen.
Mark the post.
Am Pfosten markieren.
Marquer sur un poteaux.

2.

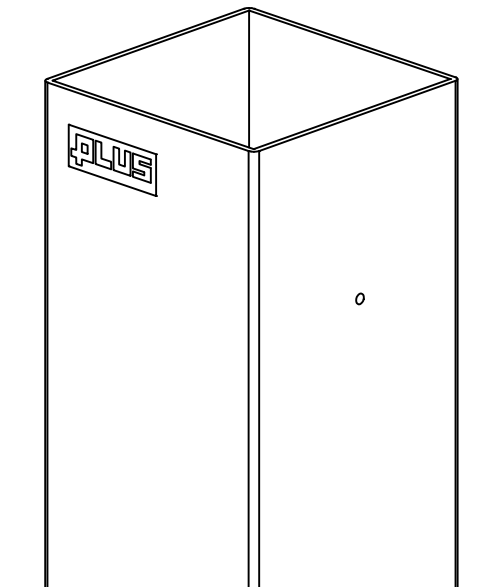
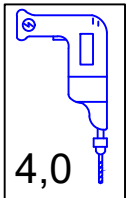

5,5 x 25 mm

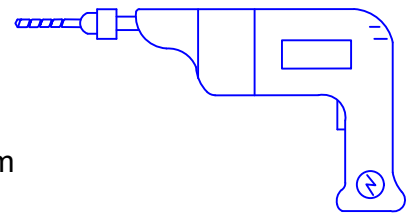

Forbores med 4,0 mm bor
Predrilled with 4,0 mm drill
Mit einen 4,0 mm Bohrer
vorbohren
Avec un foret de 4,0 mm

3.

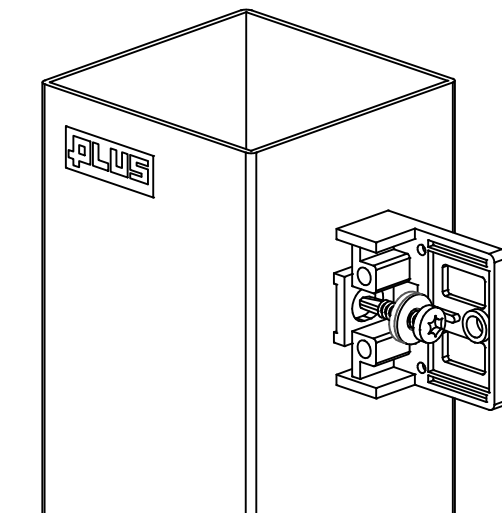
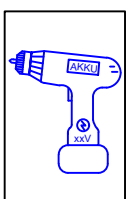

Beslaget monteres
Bracket mounted
Halterung montiert
Monté sur étrier

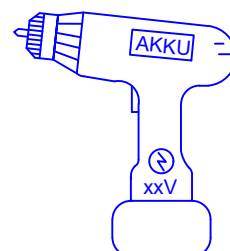

Compositstolper - WPC Pfosten - Composite posts - Poteaux composites

1.

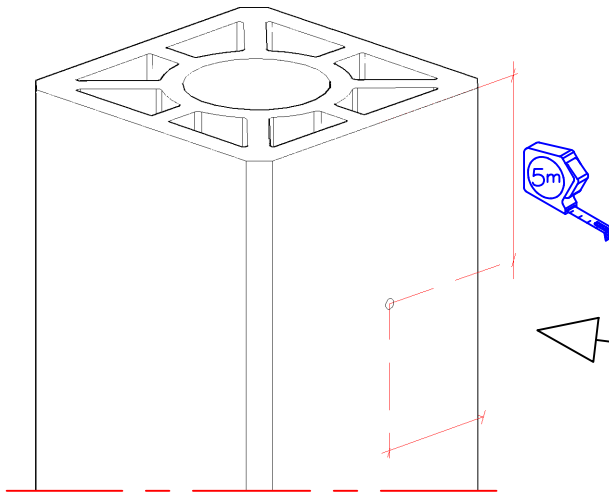
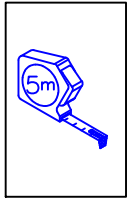

Afmærk på stolpen.
Mark the post.
Am Pfosten markieren.
Marquer sur un poteaux.

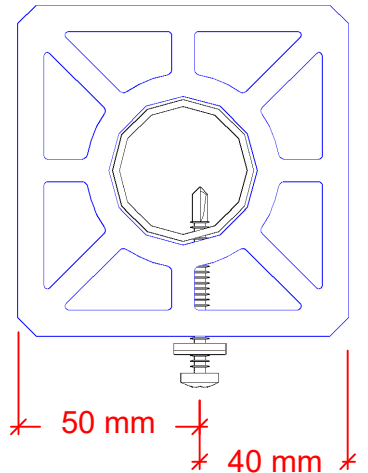

2.

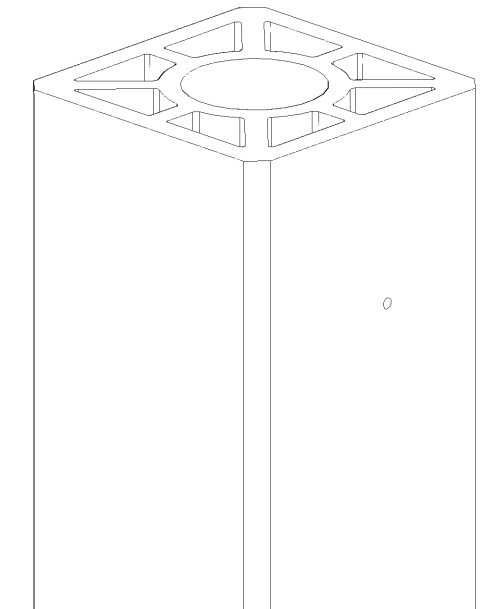
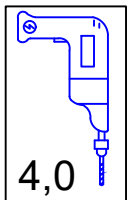

5,5 x 50 mm

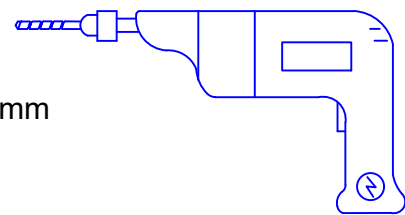

Forbores med 4,0 mm bor
Predrilled with 4,0 mm drill
Mit einen 4,0 mm Bohrer
vorbohren
Avec un foret de 4,0 mm

3.

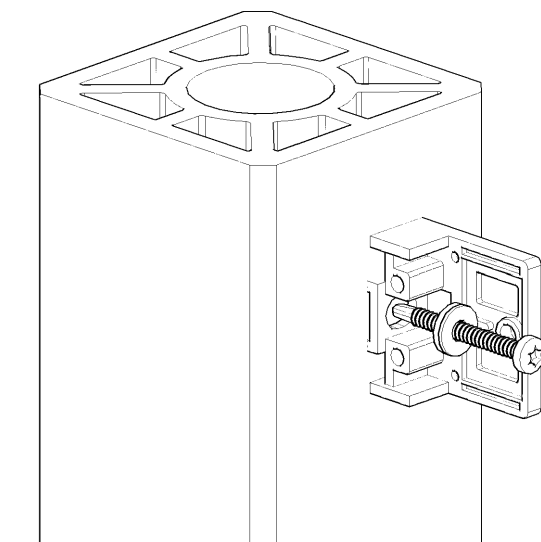
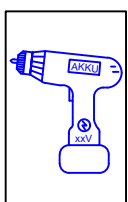

Beslaget monteres
Bracket mounted
Halterung montiert
Monté sur étrier

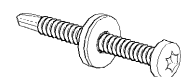
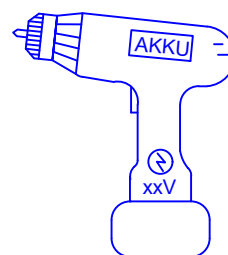

D

17524-1/15 + 175240-1/15

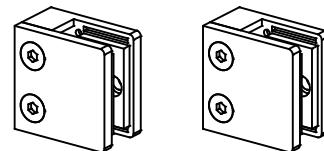

Tips:

Glasbeslagene kan monteres på husmuren, men det kræver at muren er helt lige. Desuden anbefaler vi at beslagene fastskrues i mursten - ikke i fugen. Brug rawplugs og skruer, der passer til det pågældende murværk - spørg i byggemarkedet.

Tips:

Die Glasbeschläge können an der Hauswand montiert werden, allerdings muss die Wand völlig gerade sein. Außerdem empfehlen wir, die Halterungen in den Ziegeln zu verschrauben - nicht in der Fuge. Verwenden Sie Rohdübel und Schrauben, die zum jeweiligen Mauerwerk passen - fragen Sie im Baumarkt nach.

Tips:

The glass fittings can be mounted on the house wall, but it requires the wall to be completely straight. In addition, we recommend that the brackets are screwed into bricks - not in the joint. Use rawplugs and screws that fit the particular masonry - ask in the construction market.

Tips:

Glasbeslagene kan monteres på husmuren, men det kræver at muren er helt lige. Desuden anbefaler vi at beslagene fastskrues i mursten - ikke i fugen. Brug rawplugs og skruer, der passer til det pågældende murværk - spørg i byggemarkedet.

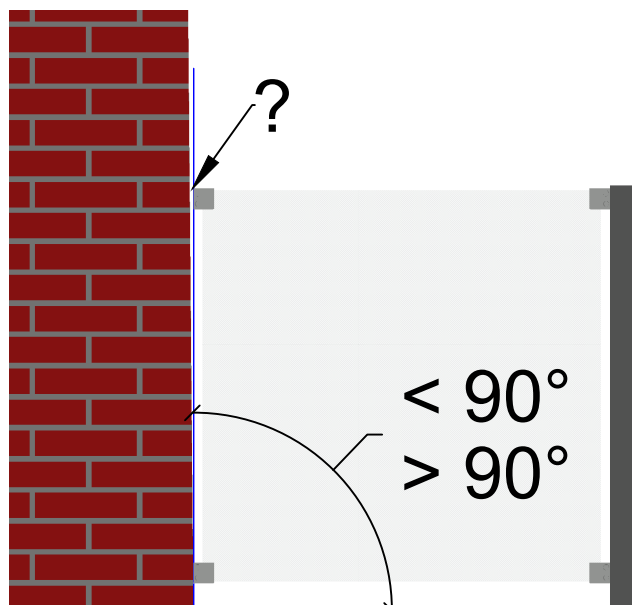
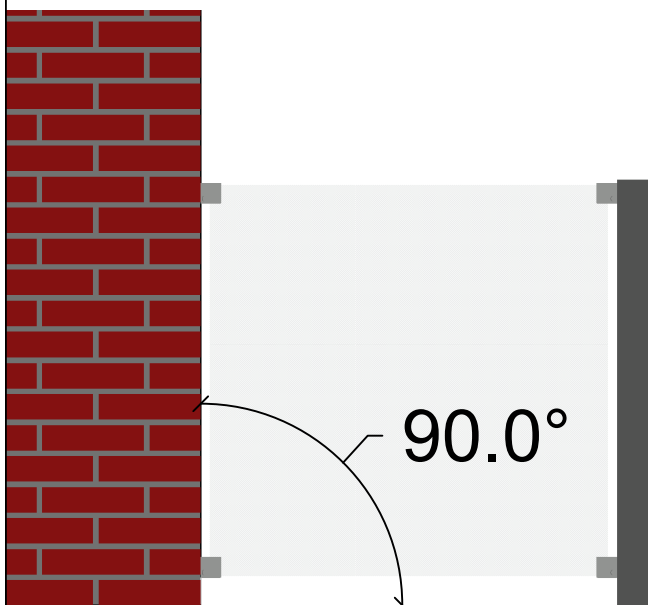
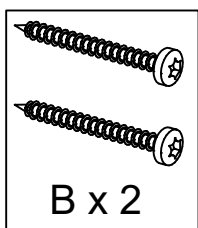
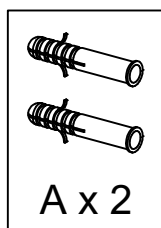

1.

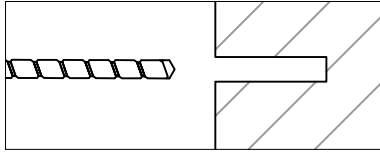

2.

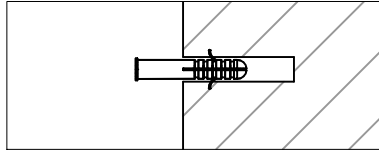

3.

